

MANUAL

FIRE DETECTION & ALARM SYSTEM

Moorebank Intermodal Facility

CASC UNIT	Date of Pre-Commissioning	Date of Final Commissioning
ASC01	25/05/2021	31/1/2024
ASC02	25/05/2021	31/1/2024
ASC03	27/05/2021	31/1/2024
ASC04	27/05/2021	31/1/2024

Rev.3

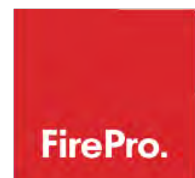
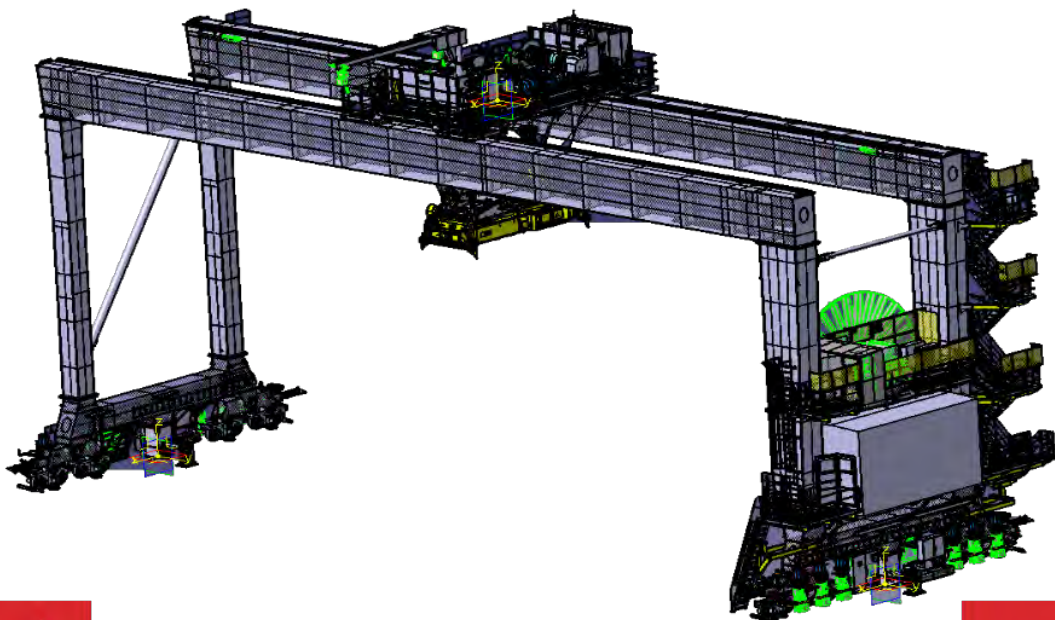

Contents

1.	Contact Details	3
2.	Description of Works	3
2.1.	System Description	3
3.	Baseline Data.....	5
3.1.	Equipment List	5
3.2.	Primary and Secondary Power Source Calculations	6
3.3.	Cause and Effects Matrix.....	6
3.4.	Design Calculations for FirePro Aerosol Fire Suppression System	7
4.	Installation, Operation & Maintenance Manuals	9
4.1.	SIGMA XT Fire Control Panel	9
4.2.	Warning Signs.....	40
4.3.	Local Control Station.....	51
4.4.	Thermal Fuse	63
5.	Equipment Data Sheets	67
5.1.	SIGMA XT Conventional Fire Control Panel	67
5.2.	Local Control Station.....	68
5.3.	Sub Indicator Panel – FP-C2.....	69
5.4.	FP-0100S Firepro Aerosol Generator	76
5.5.	FP-0200S FirePro Aerosol Generator	77
5.6.	FP-0500S FirePro Aerosol Generator	78
5.7.	FP-3000S Firepro Aerosol Generator	79
5.8.	Conventional Detectors - PE Smoke & Thermal.....	80
5.9.	Linear Heat Detection Cable	81
5.10.	Sounder Strobe	85
5.11.	Warning Signs.....	86
5.12.	Cable.....	87
5.13.	Battery	89
6.	Compliance Certificates & Commissioning Reports.....	90
6.1.	ASC01.....	90
6.2.	ASC02.....	92
6.3.	ASC03.....	94
6.4.	ASC04.....	96
7.	Maintenance Requirements.....	98
7.1.	Summary of Maintenance – AS1851 and AS 4487	98
7.2.	Extract from AS1851 – Maint. of Fire Detection and Alarm Systems	102
7.3.	Maintenance of FirePro Systems	109
8.	As Built Drawings	113

1. Contact Details

Installer:	Fire Safety Equipment Pty Ltd 2/110 Bonds Road Riverwood NSW 2210	Contact: Phil Morris Phone: 02 9153-7578 E-mail: info@fsequip.com.au
Supplier:	Incite Fire Block Y, Unit 1 Regents Park Estate, 391 Park Road REGENTS PARK NSW 2143	Contact: Phone: 1300 462 483 02 9644-7144 Technical support@incitefire.com.au
Designer:	Fire Safety Equipment Pty Ltd 2/110 Bonds Road Riverwood NSW 2210	Contact: Phil Morris Phone: 02 9153-7578 E-mail: info@fsequip.com.au

2. Description of Works

CASC Cranes have an E-house which contains the main control equipment for the crane. This also contains an 11KV Transformer.

The approximate locations of the T-House and E House are as shown.

The main FirePro Fire Suppression System is installed in the E-House, and to be connected to the site wide fire Reporting System, so that any Fire or Fault condition will be reported to site management.

A sub FIP is located in the T-House, and independently controls the Fire System for the T-House. This sub FIP reports back the the E-House panel, and the site wide Fire system

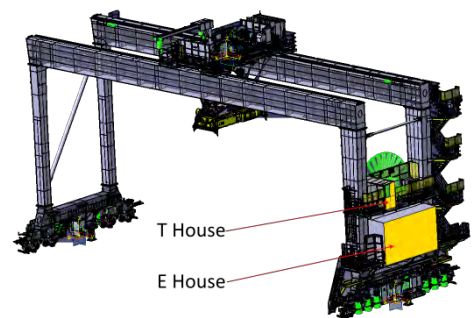

2.1. System Description

	E-House		T-House	
	Control Room	Quite Room	Control Bay	Transformer Bay
Certification	UL2775/AS4487-2013 design calculation			
Gross Volume	51.28 m ³	Not Protected with Suppression System. Detectors only	3.17 m ³	5.47 m ³
Design Concentration	5,600g		346g	346g
Total Agent Provided	6,000g – 107%		400g – 115%	400g – 115%
Leakage Allowance	0.10 m ²		0.10 m ²	0.10 m ²
Generators Installed	2 x FP-3000 Dims: 300x300x185mm Stream Length: 4.0 m		2 x FP-200S Dims: 190 x 88mm diam. Stream Length: 2.0 m	1 x FP-100S Dims: 160 x 88mm diam. Stream Length: 1.0 m 1 x FP-500S Dims: 290 x 88mm diam. Stream Length: 2.0 m

Electrical & FirePro System –

E-House

- INCITE Fire Indicator Panel(FIP) which conforms to AS7240, has 1 gas card, minimum 24 hour battery backup, individually monitors each generator.
- FIP will provide an alarm & fault indication to the master system as per AS1670.
- Two x dual knock detection circuits as per AS4487-
- Circuit 1 - 5 x photo electric smoke detectors.
- Circuit 2 - 5 x combined rate-of-rise and 90°C fixed temperature point detectors.
- Local control stations – Located internally at the exit door – provides status indication & manual release of the FirePro agent into the risk.
- Warning signs (IP55) – audible & visual. As per AS 4487:
- External above each entry door – **combined 'Fire Alarm' and ' Do Not Enter Sign'**

- In each area is – **combined 'Fire Alarm' and 'Evacuate Area Sign'**
- System inoperative signs, when system is isolated or any fault in the system..
- 3 x Visual/audible combined sounder/beacon.
- All generators are 304 SS finish with 316 SS mounting brackets.
- Cabling is UL listed 2 hour fire rated red, screened cable.

System operation-

- Either detection circuit goes into alarm –
 - Notification to main AFP3030 FIP serving the site.
 - Complete shutdown of All systems.
 - Internal audio-visual alarms.
 - Warning signs will operate.
- Both detection circuits –
 - HV power to transformer shut down
 - All of the 5 of the Aerosol Generators will discharge for approx. 20 seconds.

T-House

- INCITE Fire Sub Indicator Panel(FIP).
- FIP will provide an alarm & fault indication to the master system as per AS1670.
- Detection Via Linear Heat Detection Cable 185°C run as a single zone
- Cabling is UL listed 2 hour fire rated red, screened cable.

System operation-

- Linear heat reaches temperature of 185°C will cause activation of the system in the T-House.arm –
 - Notification to main Sigma Panel in E-House then to AFP3030 FIP serving the site.
 - Complete shutdown of All systems.
 - Internal audio-visual alarms.
 - Warning signs will operate.

3. Baseline Data

3.1. Equipment List

Item	Description	Quantity	Agent/Distributor	Model/Part No.	OEM1	Power Supply Rating (A)	Battery Charger Rating (A)	Quiescent Current (mA) per device	Alarm current (mA) per device	Fixed Service Life (years)	Nominated Service Life (years)	Installed to AS 1670.1	Installed to AS 4487	Maintenance Requirements to AS 1851
E-House														
1	Fire Indicator Panel (FIP) - 8 zone	1	Fire Safety Equipment	FP-90811	Hochiki	5	0.7	65	105	NS ⁽¹⁾	10 ⁽²⁾	Y		Section 7
4	Photo Electric Smoke Detector	6	Fire Safety Equipment	FP-94240	Hochiki			0.04	80	NS ⁽¹⁾	10 ⁽²⁾	Y		Section 7
5	Thermal detector Combined RoR & Fixed Temp.60°C	6	Fire Safety Equipment	FP-94210	Hochiki			8	28	NS ⁽¹⁾	5 ⁽²⁾	Y		Section 7
6	Sign - System Inoperative	2	Fire Safety Equipment	FP-92400	Incite			20	140	NS ⁽¹⁾	10 ⁽²⁾		Y	Section 7
7	Sign - Fire Alarm Do Not Enter	2	Fire Safety Equipment	FP-92100	Incite			20	140	NS ⁽¹⁾	10 ⁽²⁾		Y	Section 7
8	Sign - Fire Alarm Evacuate Area	2	Fire Safety Equipment	FP-92500	Incite			20	140	NS ⁽¹⁾	10 ⁽²⁾		Y	Section 7
9	Local Control Station/Remote Status Unit	1	Fire Safety Equipment	FP-90901	Incite			33	60	NS ⁽¹⁾	10 ⁽²⁾		Y	Section 7
10	Thermal fuse	1	Fire Safety Equipment	FP-08825	FSE					NS ⁽¹⁾	10 ⁽²⁾		Y	Section 7
12	Sounder/Strobe	2	Fire Safety Equipment	FP-08940	FSE				85	NS ⁽¹⁾	10 ⁽²⁾	Y		Section 7
13	Aerosol Generator – 3000g	4	Fire Safety Equipment	FP-3000S	FSE					15	10 ⁽²⁾		Y	Section 7
14	Aerosol Generator – 2000g	1	Fire Safety Equipment	FP-2000S	FSE					15	10 ⁽²⁾		Y	Section 7
15	Battery – 12v 10Ah	2								1	1	Y		Section 7
T-House														
16	Sub Indicator Panel	1	Fire Safety Equipment	FP-C2	Incite	NA	NA	18	150	NS ⁽¹⁾		Y		Section 7
17	Linear Heat Detection - 1m	1	Fire Safety Equipment	FP-09510-01	FSE					NS ⁽¹⁾		Y		Section 7
18	Linear Heat Detection - 2m	1	Fire Safety Equipment	FP-09510-02	FSE					NS ⁽¹⁾		Y		Section 7
19	Aerosol Generator – 100g	1	Fire Safety Equipment	FP-0100S	FSE					15	10		Y	Section 7
20	Aerosol Generator – 200g	1	Fire Safety Equipment	FP-0200S	FSE					15	10		Y	Section 7
21	Aerosol Generator – 500g	1	Fire Safety Equipment	FP-0500S	FSE					15	10		Y	Section 7

Notes

- (1) NS - not specified
- (2) Estimated as we have no experience in the harsh environment, components generally subjected to regular testing (at least annually)

3.2. Primary and Secondary Power Source Calculations



Battery Calculation

Client :	Kalmar Equipment Australia
Project :	ASC E-House & T-House
Notes	

Date: 01/06/2021
Rev: 21.7

Quantity Installed	Load per Unit Quiesant Milliamps	Total Load Quiesant	Quantity In Alarm	Load per Unit Alarm Milliamps	Total Load Alarm Milliamps
--------------------	----------------------------------	---------------------	-------------------	-------------------------------	----------------------------

Sigma XT - 8 Zone

Alarm Module	1	90	90.00	1	150	150.00
Extinguishant Module	1	54	54.00	1	105	105.00
Sequental Activator	1	10	10.00	1	100	100.00
Total Panel			154.00			355.00

Externals / Other Equipment

Conv Smoke PE Hockiki	2			1		
Conv ROR & 60° Thermal	2			1		
Linear Heat Det 180deg	0	0		1	0	
Hohiki IR3 Flame Det		1			28	
Signs - FAEA, FADNE, SI	3	20	60.00	3	140	420.00
Local Control Station	1	60	60.00	1	70	70.00
Flashni Sounder/Strobe	3	0		3	60	180.00
FPC2 Control Panel	1	18	18.00	1	150	150.00
Total Other Equipment			138.00			820.00

Alarm & Detection Module Incl EOL's
Extinguishant Module Incl EOL's
Only one is active at a time

Incl In Alarm Module
Incl In Alarm Module
Incl In Alarm Module
Incl In Alarm Module
1 Flame in Alarm

Quiescent in panel calcs. 0 used by sounder.

Total Quiesant Current (A)		292.00 (IQ)	1,175.00 (IA)
Standby Time - Quiesant	Hours	24.00 (TQ)	1.25
Standby Time - Alarm	Hours	0.50 (TA)	2.00 (FC)

Total Current in Alarm State (A)
Compensation Factor for Battery Deterioration
Battery Capacity Derating Factor

Minimum Required Battery Capacity 9 Ah (C20) Battery Part Number - FP-90909

Notes :

- Determine the quiescent load current IQ.
- Determine the alarm current IA.
- Determine the capacity de-rating factor FC of battery when discharged at the alarm load rate taking into account the minimum operating voltage of the connected CIE using the battery manufacturer's data. Where more than one CIE is connected to the battery, use the highest minimum of any of the CIEs. A value of 2 for FC is deemed to satisfy these requirements.
- The 20 h discharge battery capacity C20 at 15°C to 30°C shall be determined as follows:
- $C20 = 1.25 [(IQ \times TQ) + FC (IA \times TA)]$

where : C20 = battery capacity in Ah at 20 h discharge rate
TA = alarm load standby power source time (normally 0.5 h)
TQ = quiescent standby power source time, (normally 24 h)
1.25 = compensation factor for expected battery deterioration

IA = total current in alarm state
IQ = total quiescent current
FC = capacity de-rating factor

3.3. Cause and Effects Matrix

Kalmar ASC Cranes Fire Suppression System for E House		Installer	Fire Safety Equipment 2/110 Bonds Road Riverwood, NSW 2210 T: 02 9153-7578 E: info@fsequip.com.au		
Device in Alarm	Fire Alarm Output To Main FDCIE	Activation of Aerosol Generators after time delay	Shutdown Airconditioning and Ventilation fans	Shutdown LV power to EHouse	
E-House					
Zone 1 - Smoke detector circuit	X		X	X	
Zone 2 - Thermal detector circuit	X		X	X	
Zone 1 & Zone 2	X	X			
T-House					
Linear Heat Detection	X	X	X	X	

3.4. Design Calculations for FirePro Aerosol Fire Suppression System

FirePro. <small>Reinventing Fire Suppression</small>		GENERAL APPLICATION						1/06/2021 Rev: 21.7																																																																																																							
<p>CLIENT NAME Kalmr Equipment Australia</p> <p>Risk Description ASC E-House</p> <p>Constructed from Steel</p> <p><input checked="" type="checkbox"/> Class A <input type="checkbox"/> Class B <input checked="" type="checkbox"/> Class E <input type="checkbox"/> Class D <input type="checkbox"/> Class F</p> <p>GROSS DIMENSIONS Length: 2.75 x Width: 5.60 x Height: 3.33 = Not Used m³</p> <p>Actual Leakage Measurement - m² = m²</p> <p>Leakage Allowance without additional Agent = 0.10 m²</p> <p>GROSS Volume used for Calculation = 51.28 m³</p> <p>PRIMARY AGENT DISCHARGE = 5,600 g</p> <p>Secondary Agent Discharge = - g</p>	<table border="1" style="width:100%; border-collapse: collapse; text-align: center;"> <thead> <tr> <th rowspan="2">Model</th> <th rowspan="2">L2 (mm)</th> <th rowspan="2">L3 (mm)</th> <th rowspan="2">Stream (mm)</th> <th rowspan="2">Agent Qty</th> <th colspan="2">Concentration</th> <th rowspan="2">Primary Quantity</th> <th rowspan="2">Secondary Quantity</th> </tr> <tr> <th>Primary</th> <th>Secondary</th> </tr> </thead> <tbody> <tr><td>FP-0020</td><td>0</td><td>0</td><td>1000</td><td>20</td><td>-</td><td>-</td><td></td><td></td></tr> <tr><td>FP-0040</td><td>0</td><td>0</td><td>1000</td><td>40</td><td>-</td><td>-</td><td></td><td></td></tr> <tr><td>FP-0080</td><td>0</td><td>0</td><td>1000</td><td>80</td><td>-</td><td>-</td><td></td><td></td></tr> <tr><td>FP-0100</td><td>0</td><td>200</td><td>1000</td><td>100</td><td>-</td><td>-</td><td></td><td></td></tr> <tr><td>FP-0200</td><td>0</td><td>300</td><td>2000</td><td>200</td><td>-</td><td>-</td><td></td><td></td></tr> <tr><td>FP-0500</td><td>100</td><td>500</td><td>2000</td><td>500</td><td>-</td><td>-</td><td></td><td></td></tr> <tr><td>FP-1200</td><td>0</td><td>1500</td><td>3500</td><td>1,200</td><td>-</td><td>-</td><td></td><td></td></tr> <tr><td>FP-2000</td><td>0</td><td>1500</td><td>3500</td><td>2,000</td><td>-</td><td>-</td><td></td><td></td></tr> <tr><td>FP-3000</td><td>600</td><td>2000</td><td>3500</td><td>3,000</td><td>6,000</td><td>-</td><td>2</td><td></td></tr> <tr><td>FP-5700</td><td>600</td><td>2000</td><td>8400</td><td>5,700</td><td>-</td><td>-</td><td></td><td></td></tr> </tbody> </table> <table border="1" style="width:100%; border-collapse: collapse; text-align: right;"> <tr><td>Total Concentration</td><td>6,000</td><td>-</td></tr> <tr><td>Required Concentration</td><td>5,600</td><td>-</td></tr> <tr><td>% Required Concentration</td><td>107%</td><td>-</td></tr> </table> <p><input checked="" type="checkbox"/> Design Calculation has been Confirmed</p> <p><input checked="" type="checkbox"/> FirePro Units have suitable STREAM length for Risk Area Coverage</p> <p><input type="checkbox"/> Leakage compensation made in Primary Discharge</p> <p><input type="checkbox"/> Additional HOLD time Required for the risk</p> <div style="text-align: center; background-color: red; color: white; padding: 10px; font-size: 24px; font-weight: bold;">APPROVED</div> <p>Prepared By: PM Company: FSE</p>	Model	L2 (mm)	L3 (mm)	Stream (mm)	Agent Qty	Concentration		Primary Quantity	Secondary Quantity	Primary	Secondary	FP-0020	0	0	1000	20	-	-			FP-0040	0	0	1000	40	-	-			FP-0080	0	0	1000	80	-	-			FP-0100	0	200	1000	100	-	-			FP-0200	0	300	2000	200	-	-			FP-0500	100	500	2000	500	-	-			FP-1200	0	1500	3500	1,200	-	-			FP-2000	0	1500	3500	2,000	-	-			FP-3000	600	2000	3500	3,000	6,000	-	2		FP-5700	600	2000	8400	5,700	-	-			Total Concentration	6,000	-	Required Concentration	5,600	-	% Required Concentration	107%	-
Model	L2 (mm)						L3 (mm)	Stream (mm)			Agent Qty	Concentration		Primary Quantity	Secondary Quantity																																																																																																
		Primary	Secondary																																																																																																												
FP-0020	0	0	1000	20	-	-																																																																																																									
FP-0040	0	0	1000	40	-	-																																																																																																									
FP-0080	0	0	1000	80	-	-																																																																																																									
FP-0100	0	200	1000	100	-	-																																																																																																									
FP-0200	0	300	2000	200	-	-																																																																																																									
FP-0500	100	500	2000	500	-	-																																																																																																									
FP-1200	0	1500	3500	1,200	-	-																																																																																																									
FP-2000	0	1500	3500	2,000	-	-																																																																																																									
FP-3000	600	2000	3500	3,000	6,000	-	2																																																																																																								
FP-5700	600	2000	8400	5,700	-	-																																																																																																									
Total Concentration	6,000	-																																																																																																													
Required Concentration	5,600	-																																																																																																													
% Required Concentration	107%	-																																																																																																													
Aust. Std Design Notes																																																																																																															
Pre-Engineered Design Calculation																																																																																																															
<p><small>CALCULATION OF VOLUME : Calculation is based on Gross Volume with NO deductions for any Objects that occupy volume within the protected space. This category covers fixed condensed aerosol extinguishing system units intended for total flooding applications. AS 4487 and AS5062.</small></p> <p>Minimum Extinguishing Factor (mef) 84 X 1.3 = 109.2</p> <ul style="list-style-type: none"> L2 is the thermal clearance required where the temperature of the discharge is less than 200° C L3 is the thermal clearance required where the temperature of the discharge is less than 75° C 																																																																																																															

FirePro. <small>Reinventing Fire Suppression</small>		GENERAL APPLICATION						1/06/2021 Rev: 21.7																																																																																																							
<p>CLIENT NAME Kalmr Equipment Australia</p> <p>Risk Description ASC T-House Control</p> <p>Constructed from Steel</p> <p><input checked="" type="checkbox"/> Class A <input type="checkbox"/> Class B <input checked="" type="checkbox"/> Class E <input type="checkbox"/> Class D <input type="checkbox"/> Class F</p> <p>GROSS DIMENSIONS Length: 1.10 x Width: 1.20 x Height: 2.40 = Not Used m³</p> <p>Actual Leakage Measurement - m² = m²</p> <p>Leakage Allowance without additional Agent = 0.10 m²</p> <p>GROSS Volume used for Calculation = 3.17 m³</p> <p>PRIMARY AGENT DISCHARGE = 346 g</p> <p>Secondary Agent Discharge = - g</p>	<table border="1" style="width:100%; border-collapse: collapse; text-align: center;"> <thead> <tr> <th rowspan="2">Model</th> <th rowspan="2">L2 (mm)</th> <th rowspan="2">L3 (mm)</th> <th rowspan="2">Stream (mm)</th> <th rowspan="2">Agent Qty</th> <th colspan="2">Concentration</th> <th rowspan="2">Primary Quantity</th> <th rowspan="2">Secondary Quantity</th> </tr> <tr> <th>Primary</th> <th>Secondary</th> </tr> </thead> <tbody> <tr><td>FP-0020</td><td>0</td><td>0</td><td>1000</td><td>20</td><td>-</td><td>-</td><td></td><td></td></tr> <tr><td>FP-0040</td><td>0</td><td>0</td><td>1000</td><td>40</td><td>-</td><td>-</td><td></td><td></td></tr> <tr><td>FP-0080</td><td>0</td><td>0</td><td>1000</td><td>80</td><td>-</td><td>-</td><td></td><td></td></tr> <tr><td>FP-0100</td><td>0</td><td>200</td><td>1000</td><td>100</td><td>-</td><td>-</td><td></td><td></td></tr> <tr><td>FP-0200</td><td>0</td><td>300</td><td>2000</td><td>200</td><td>400</td><td>-</td><td>2</td><td></td></tr> <tr><td>FP-0500</td><td>100</td><td>500</td><td>2000</td><td>500</td><td>-</td><td>-</td><td></td><td></td></tr> <tr><td>FP-1200</td><td>0</td><td>1500</td><td>3500</td><td>1,200</td><td>-</td><td>-</td><td></td><td></td></tr> <tr><td>FP-2000</td><td>0</td><td>1500</td><td>3500</td><td>2,000</td><td>-</td><td>-</td><td></td><td></td></tr> <tr><td>FP-3000</td><td>600</td><td>2000</td><td>3500</td><td>3,000</td><td>-</td><td>-</td><td></td><td></td></tr> <tr><td>FP-5700</td><td>600</td><td>2000</td><td>8400</td><td>5,700</td><td>-</td><td>-</td><td></td><td></td></tr> </tbody> </table> <table border="1" style="width:100%; border-collapse: collapse; text-align: right;"> <tr><td>Total Concentration</td><td>400</td><td>-</td></tr> <tr><td>Required Concentration</td><td>346</td><td>-</td></tr> <tr><td>% Required Concentration</td><td>115%</td><td>-</td></tr> </table> <p><input checked="" type="checkbox"/> Design Calculation has been Confirmed</p> <p><input checked="" type="checkbox"/> FirePro Units have suitable STREAM length for Risk Area Coverage</p> <p><input type="checkbox"/> Leakage compensation made in Primary Discharge</p> <p><input type="checkbox"/> Additional HOLD time Required for the risk</p> <div style="text-align: center; background-color: red; color: white; padding: 10px; font-size: 24px; font-weight: bold;">APPROVED</div> <p>Prepared By: PM Company: FSE</p>	Model	L2 (mm)	L3 (mm)	Stream (mm)	Agent Qty	Concentration		Primary Quantity	Secondary Quantity	Primary	Secondary	FP-0020	0	0	1000	20	-	-			FP-0040	0	0	1000	40	-	-			FP-0080	0	0	1000	80	-	-			FP-0100	0	200	1000	100	-	-			FP-0200	0	300	2000	200	400	-	2		FP-0500	100	500	2000	500	-	-			FP-1200	0	1500	3500	1,200	-	-			FP-2000	0	1500	3500	2,000	-	-			FP-3000	600	2000	3500	3,000	-	-			FP-5700	600	2000	8400	5,700	-	-			Total Concentration	400	-	Required Concentration	346	-	% Required Concentration	115%	-
Model	L2 (mm)						L3 (mm)	Stream (mm)			Agent Qty	Concentration		Primary Quantity	Secondary Quantity																																																																																																
		Primary	Secondary																																																																																																												
FP-0020	0	0	1000	20	-	-																																																																																																									
FP-0040	0	0	1000	40	-	-																																																																																																									
FP-0080	0	0	1000	80	-	-																																																																																																									
FP-0100	0	200	1000	100	-	-																																																																																																									
FP-0200	0	300	2000	200	400	-	2																																																																																																								
FP-0500	100	500	2000	500	-	-																																																																																																									
FP-1200	0	1500	3500	1,200	-	-																																																																																																									
FP-2000	0	1500	3500	2,000	-	-																																																																																																									
FP-3000	600	2000	3500	3,000	-	-																																																																																																									
FP-5700	600	2000	8400	5,700	-	-																																																																																																									
Total Concentration	400	-																																																																																																													
Required Concentration	346	-																																																																																																													
% Required Concentration	115%	-																																																																																																													
Aust. Std Design Notes																																																																																																															
Pre-Engineered Design Calculation																																																																																																															
<p><small>CALCULATION OF VOLUME : Calculation is based on Gross Volume with NO deductions for any Objects that occupy volume within the protected space. This category covers fixed condensed aerosol extinguishing system units intended for total flooding applications. AS 4487 and AS5062.</small></p> <p>Minimum Extinguishing Factor (mef) 84 X 1.3 = 109.2</p> <ul style="list-style-type: none"> L2 is the thermal clearance required where the temperature of the discharge is less than 200° C L3 is the thermal clearance required where the temperature of the discharge is less than 75° C 																																																																																																															

CLIENT NAME: **Kalmar Equipment Australia**
 Risk Description: **ASC T-House Transformer**
 Constructed from: **Steel**

- Class A Class B Class E Class D Class F

GROSS DIMENSIONS: Length **1.90** x Width **1.20** x Height **2.40** = **Not Used** m³
 Actual Leakage Measurement - m² = **Not Used** m²

Leakage Allowance without additional Agent = **0.10** m²

GROSS Volume used for Calculation = **5.47** m³

PRIMARY AGENT DISCHARGE = **598** g

Secondary Agent Discharge = **-** g

Model	L2 (mm)	L3 (mm)	Stream (mm)	Agent Qty	Concentration		Primary Quantity	Secondary Quantity
					Primary	Secondary		
FP-0020	0	0	1000	20	-	-		
FP-0040	0	0	1000	40	-	-		
FP-0080	0	0	1000	80	-	-		
FP-0100	0	200	1000	100	100	-	1	
FP-0200	0	300	2000	200	-	-		
FP-0500	100	500	2000	500	500	-	1	
FP-1200	0	1500	3500	1,200	-	-		
FP-2000	0	1500	3500	2,000	-	-		
FP-3000	600	2000	3500	3,000	-	-		
FP-5700	600	2000	8400	5,700	-	-		

Total Concentration	600	-
Required Concentration	598	-
% Required Concentration	100%	

- Design Calculation has been Confirmed
- FirePro Units have suitable STREAM length for Risk Area Coverage
- Leakage compensation made in Primary Discharge
- Additional HOLD time Required for the risk

Aust. Std Design Notes

Pre-Engineered Design Calculation

CALCULATION OF VOLUME : Calculation is based on Gross Volume with NO deductions for any Objects that occupy volume within the protected space. This category covers fixed condensed aerosol extinguishing system units intended for total flooding applications. AS 4487 and AS5062.

Minimum Extinguishing Factor (mef) **84** X **1.3** = **109.2**

- L2 is the thermal clearance required where the temperature of the discharge is less than 200° C
- L3 is the thermal clearance required where the temperature of the discharge is less than 75° C

APPROVED

Prepared By:

PM

Company

FSE



Conventional Fire Control Panel with Extinguishant Control Unit for Aerosol Release

Operation and Maintenance Manual

Available in 2 Zone, 8 Zone, Single risk or dual risk.

Contents

1.	Introduction.....	3
2.	Access Levels.....	4
3.	Connecting to the Control Panel	5
3.1.	Warning Sign and Status Unit Connection	8
3.2.	Detection zone wiring	10
3.3.	Sounder circuit wiring	10
3.4.	Thermal Fuse Connection.....	10
4.	Multiway Sequential Activator (FirePro Units)	11
4.1.	Overview	11
4.2.	Installation.....	11
4.3.	Connection of Aerosol Units to Activation circuit	12
4.4.	Connection to FirePro Units.....	12
4.5.	Input connections.....	12
4.6.	Indications	13
4.7.	Jumper links.....	13
4.8.	Fault monitoring links	13
4.9.	Isolate slide switch	13
4.10.	Display boards	14
4.11.	Setting up extinguishant monitoring circuit.....	14
5.	Other Connections	14
5.1.	Connection to remote control terminals (not normally used).....	14
5.2.	Aux 24V DC supply	15
5.3.	Connection to relay contacts	15
5.4.	Shutdown Isolation Switch	16
6.	Configuring the panel	16
6.1.	Alarm Module.....	16
6.2.	Extinguishant Module.....	16
7.	Panel operation – Access levels 1 and 2.....	20
7.1.	Normal condition	20
7.2.	Alarm Module – Access level 2.....	21
7.3.	Extinguishant modules	21
7.4.	Single Zone and Double Zone Fire Conditions.....	23
7.5.	Silence/sound alarms.....	23
7.6.	Reset.....	23
7.7.	Fault Indicators	23
7.8.	Lamp test	24
7.9.	Lock Off condition	24
7.10.	Released condition	24
7.11.	Low pressure switch	24
7.12.	Manual only mode	24
7.13.	Manual Release	25
7.14.	Abort input.....	25
8.	FPC-2 Sub Panel	25
9.	Internal Controls and Fault Indicators (Troubleshooting)	25
9.1.	Fire Alarm Module	25
9.2.	Extinguishant Module.....	26
10.	Power Supply	27
11.	Maintenance.....	28
12.	Technical specification	28
13.	Commissioning Instructions and Record of Configuration	30

1. Introduction

IMPORTANT

AC mains power supply 230V (+10%/-15%), 50/60Hz
Operational temp -5°C (±3) and +40°C (±2) max relative humidity of 95%
Operation outside these parameters will lead to premature failure.

The FirePro SIGMA XT-A, conventional fire alarm control panel with Extinguishant Control Unit and Aerosol Agent Controller, is designed to comply with AS7240-2, AS7240-4 Fire Detection and Fire Alarm Systems - Control and Indicating Equipment, and AS ISO 14520.1 2009 Gaseous Fire Extinguishant Systems.

The control equipment is a combined fire alarm control panel and extinguishant system with up to eight detection zones, and up to two extinguishant flooding areas. It has an integral, mains powered battery charger and power supply designed in accordance with the requirements of AS7240-4.

In addition to the requirements of AS7240-2 the control panel has the following facilities:

- *Test condition* to allow the automatic resetting of zones in alarm for testing purposes.
- *Delay of the actioning* of fire alarm devices (sounders) so that an alarm may be verified before evacuation.
- Voltage free relays for fire and local fire which operate upon fire condition.

Mounting

This equipment is designed to be operated from 230V 50Hz mains supplies and is of class 1 construction. As such it **must** be connected to earth conductor in the fixed wiring of the installation and a readily accessible double pole disconnect device which disconnects live and neutral simultaneously shall be incorporated in the fixed wiring.

Failure to ensure that all conductive accessible parts of this equipment are adequately bonded to earth will render the equipment unsafe.

This control panel is designed for indoor use only and at temperatures between -5°C (+/- 3) and +40°C (+/-2) and with a maximum relative humidity of 95%. Standard panels are rated to IP30 and suitable for mounting indoors.

Operation outside of these limits may render the equipment unsafe.

MOUNTING - The control panel should be mounted on a dry, flat surface, at eye height to the display and in a level position such that the enclosure is not distorted.

Cables should be connected using cable glands fitted to the knockouts. If additional entry points are required, all swarf and debris caused by drilling of additional cable entries must be cleared before power is applied to the panel.

DIMENSIONS - H x W x D mm

M3 Cabinet : 520 x 385 x 110

Warning Sign : 195 x 300 x 50

LCS : 135 x 186 x 50

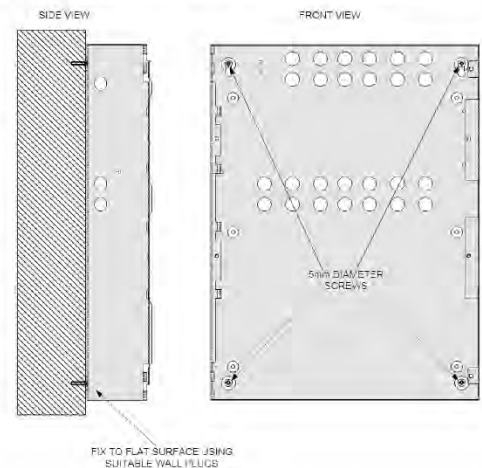

Facias



SIGMA-2-M3-FP-8
SIGMA-2-M3-FP-16



SIGMA-8-M3-FP-8
SIGMA-8-M3-FP-16



SIGMA-8-M4-FP2x8
SIGMA-8-M4-FP2x16
SIGMA-8-M4-FP2x32

The fascias are divided into sections for the Alarm Module and Extinguishant Modules. A standard AS7240-2 control and indicating equipment section with up to eight zones is located in the top aperture of the panel fascia and an AS4214 extinguishant module is fitted in the lower aperture.

2. Access Levels

For more information on Access Levels, please see Section 7 - Panel operation – Access levels 1 and 2.

Access Levels 1 and 2

The cabinet door has 3 locks:

The centre lock opens the display window, allowing for operation of the controls.

The display window contains a door switch.

Operation of this door switch places the panel in Access Level 2.



Door Switch in Access Level 1

The top and bottom locks will open the complete cabinet front allowing for full access to the panel wiring and workings.

Opening this door only WILL NOT OPERATE THE DOOR SWITCH and will not allow operation of the controls



Door Switch in Access Level 2

Access Level 3 – Slide Switches.

ALARM MODULE



Normal – The Slide Switch is to the Left



To Access Level 3 – move the Slide Switch to the Right



Access Level 3 – The Slide Switch is to the Right

A General Fault will occur if the Slide Switch is in the Access Level 3 position, and the Door Switch is returned to Access Level 1.

EXTINGUISHING MODULE



Normal – The Slide Switch is to the Right

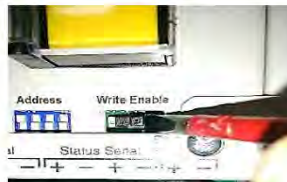

To Access Level 3 – move the Slide Switch to the Left

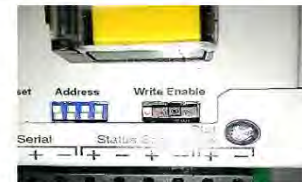

Access Level 3 – The Slide Switch is to the Left

A "CONFIG WP" Fault will occur if the Slide Switch is in the Access Level 3 position, and the Door Switch is returned to Access Level 1.

3. Connecting to the Control Panel

The Panel has 2 major components

- Alarm Module
- Extinguishant Mudule

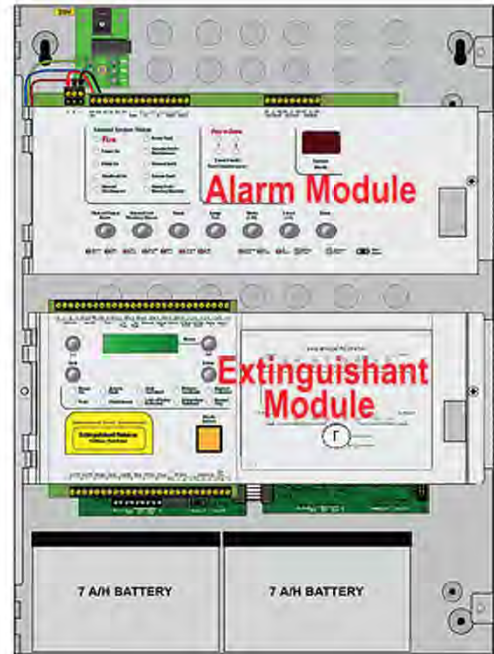

Software revision number

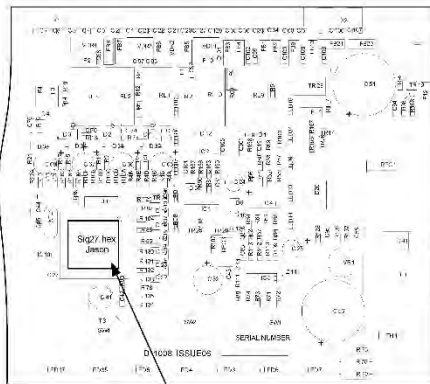

SOFTWARE VERSION LABEL

New features may be added to Sigma CP fire control panels from time to time and when this is done the operating software of the unit is updated.

The software revision can be located on the main processor by removing the plate holding the PCB from the enclosure and turning it over.

The software version will have a number such as "216.hex" and it is this number which will determine which features the panel has installed and its compatibility with Sigma CP ancillary board, sounders boards, repeaters etc.

The connections for the power cables are to a pluggable terminal block which may be pulled off of the board to remove power from the PCB assembly. Remove this pluggable terminal only with MAINS POWER **OFF**.

Cabling must comply with the Australian Standards. The resistance of any cable must not exceed 25 ohms.

Terminals are capable of accepting wires of up to 2.5mm². Wiring must not go across the front of the circuit board plate or between the plate and the circuit board. If cable entries need to be in positions other than at the knockouts provided, wiring must be fed behind and well away from the surface of the circuit board.

The space at the bottom of the enclosure is largely occupied by the batteries so this must be borne in mind when considering cable entries.

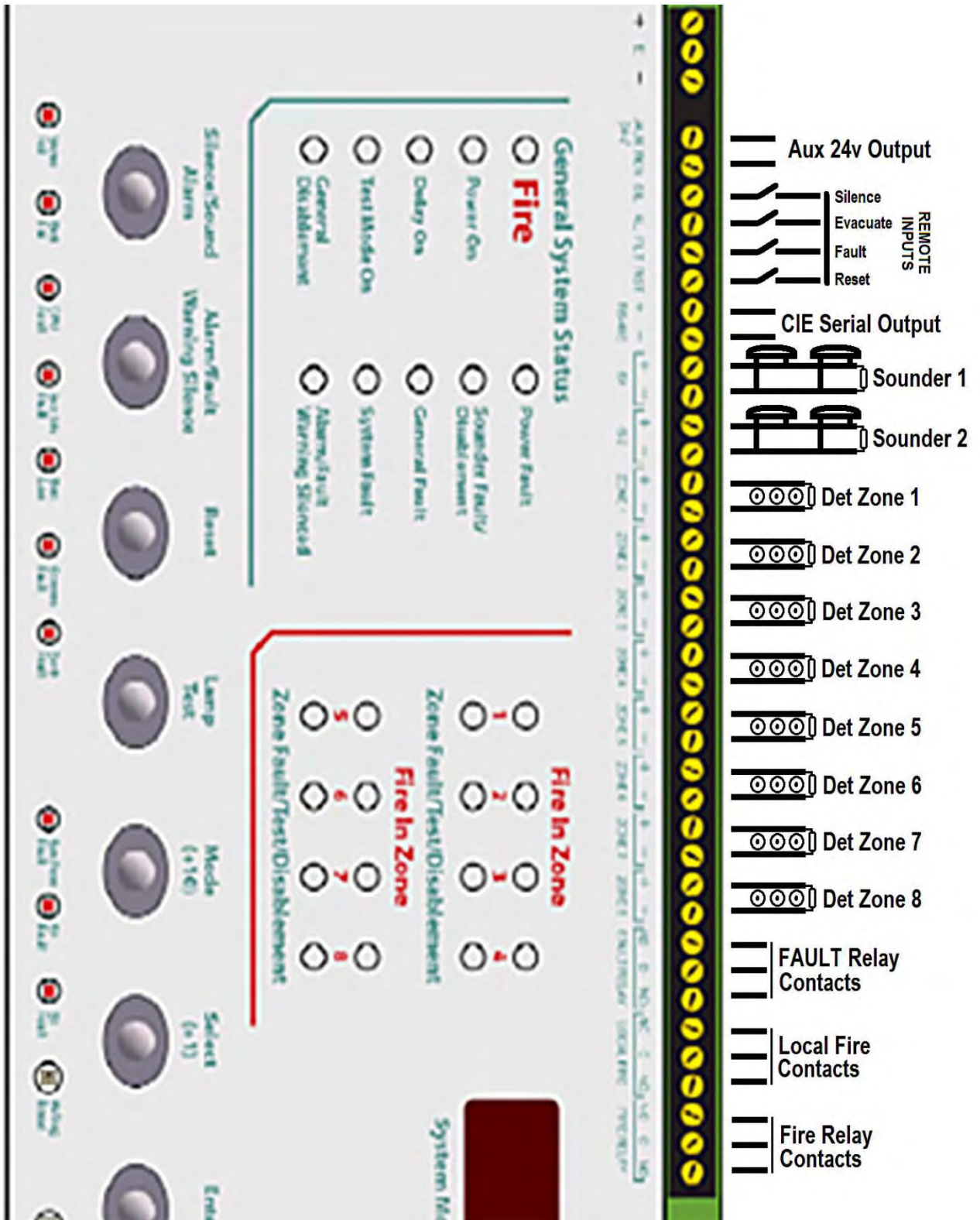

EOL Resistors

EOL Detection Circuits

6K8

EOL Sounder Circuits

10K

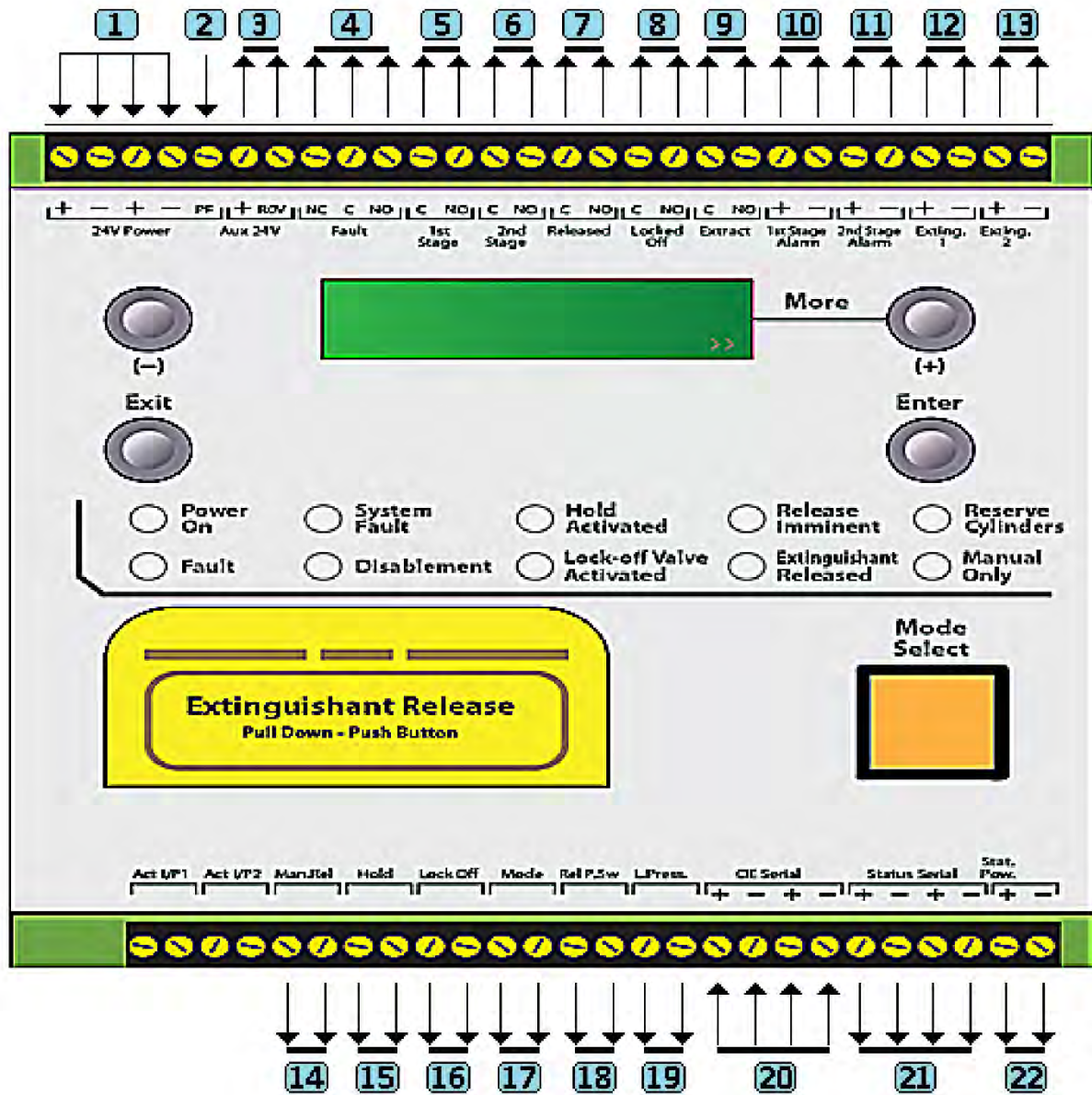

1	24vDC Input from PSU		
2	PF Input from PSU		
3	Aux 24vDC Output		
4	Fault relay Contact		
5	Stop Air Conditioning		
6	Shutdown Power		
7	Released Relay Contact		
8	Aborted Relay Contact		
9	Extract Fan Power		
10	1st Stage Sounders	EOL 10K	
11	2nd Stage Sounders	EOL 10K	
12	Releasing Solenoid		1N4004 Diode
13	Releasing Solenoid		1N4004 Diode
14	Remote Manual Release Switch		EOL 6K8
15	Remote Hold Switch		EOL 6K8
16	Remote Abort Switch		EOL 6K8
17	Remote Auto/Manual Select Switch		EOL 6K8
18	Exting Release Pressure Switch		EOL 6K8
19	Exting Low Pressure Switch		EOL 6K8
20	Internal Connection from Panel		
21	Serial data to Status Units		
22	Power to Status Units		

3.1. Warning Sign and Status Unit Connection

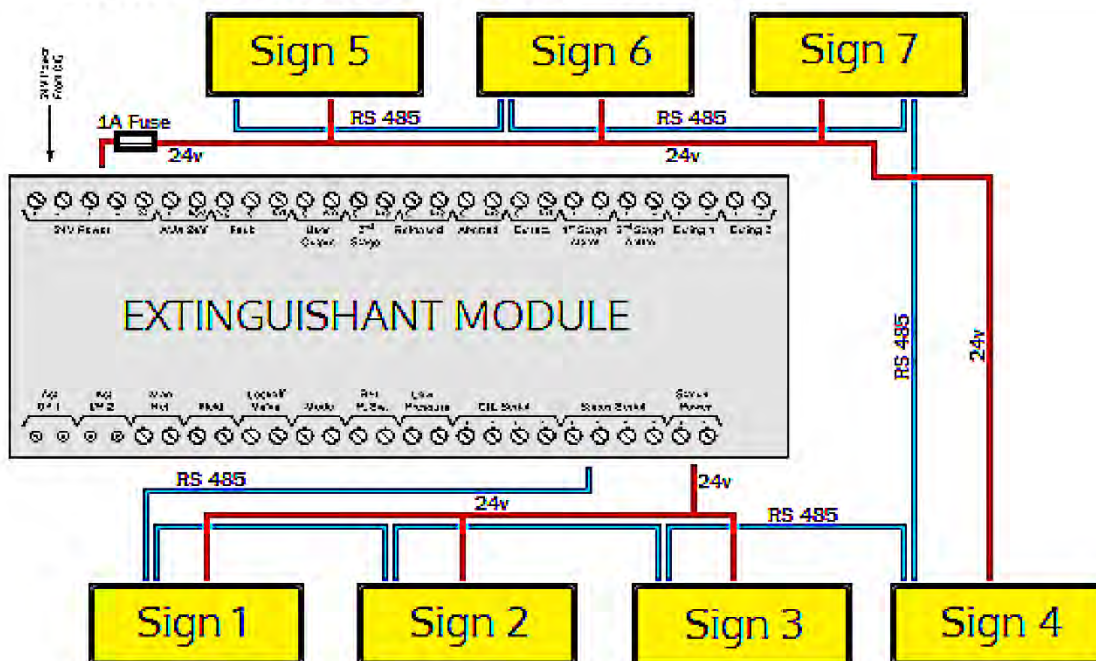

Each Sign requires **BOTH** 24v POWER and RS485 connections as shown. MAXIMUM devices 7.

Individual addresses required for each Sign. The address switch is located on the bottom left hand corner of the status unit. The address is only read when the boards are first powered, so address switches should not be altered on a system that has power applied, as changes will not be recognised. **Units with the same address will cause intermittent fault to be displayed**

	Sign 1	Sign 2	Sign 3	Sign 4	Sign 5	Sign 6	Sign 7	
ADDRESS Vertical Switch	→ ON	→ ON	→ ON	→ ON	→ ON	→ ON	→ ON	
ADDRESS Horizontal Switch	↑ ON	↑ ON	↑ ON	↑ ON	↑ ON	↑ ON	↑ ON	
FIRE ALARM DO NOT ENTER	→ ON Fire Manual Mode Manual Release Disable Released 2nd Stage Alarm Hold Sys Inop	→ ON Fire Manual Mode Manual Release Disable Released 2nd Stage Alarm Hold Sys Inop	→ ON Fire Manual Mode Manual Release Disable Released 2nd Stage Alarm Hold Sys Inop	→ ON Fire Manual Mode Manual Release Disable Released 2nd Stage Alarm Hold Sys Inop	→ ON Fire Manual Mode Manual Release Disable Released 2nd Stage Alarm Hold Sys Inop	→ ON Fire Manual Mode Manual Release Disable Released 2nd Stage Alarm Hold Sys Inop	→ ON Fire Manual Mode Manual Release Disable Released 2nd Stage Alarm Hold Sys Inop	
FIRE ALARM EVACUATE AREA	→ ON Fire Manual Mode Manual Release Disable Released 2nd Stage Alarm Hold Sys Inop	→ ON Fire Manual Mode Manual Release Disable Released 2nd Stage Alarm Hold Sys Inop	→ ON Fire Manual Mode Manual Release Disable Released 2nd Stage Alarm Hold Sys Inop	→ ON Fire Manual Mode Manual Release Disable Released 2nd Stage Alarm Hold Sys Inop	→ ON Fire Manual Mode Manual Release Disable Released 2nd Stage Alarm Hold Sys Inop	→ ON Fire Manual Mode Manual Release Disable Released 2nd Stage Alarm Hold Sys Inop	→ ON Fire Manual Mode Manual Release Disable Released 2nd Stage Alarm Hold Sys Inop	→ ON Fire Manual Mode Manual Release Disable Released 2nd Stage Alarm Hold Sys Inop
SYSTEM INOPERATIVE	→ ON Fire Manual Mode Manual Release Disable Released 2nd Stage Alarm Hold Sys Inop	→ ON Fire Manual Mode Manual Release Disable Released 2nd Stage Alarm Hold Sys Inop	→ ON Fire Manual Mode Manual Release Disable Released 2nd Stage Alarm Hold Sys Inop	→ ON Fire Manual Mode Manual Release Disable Released 2nd Stage Alarm Hold Sys Inop	→ ON Fire Manual Mode Manual Release Disable Released 2nd Stage Alarm Hold Sys Inop	→ ON Fire Manual Mode Manual Release Disable Released 2nd Stage Alarm Hold Sys Inop	→ ON Fire Manual Mode Manual Release Disable Released 2nd Stage Alarm Hold Sys Inop	→ ON Fire Manual Mode Manual Release Disable Released 2nd Stage Alarm Hold Sys Inop

3.1.1. Adding or Removing Status units

PANEL SHOULD BE POWERED DOWN before any changes are made to status units. When the system is first powered on, it will search for connected status units connected to extinguishant module. If status units are connected correctly and detected by the control panel, the LCD will display:

X FAULTS
Enter TO VIEW

Open the *Display Window* and Press *Enter* on the module to which the status units are connected. Use the "+" button on the module to view the faults. If status units are detected the LCD will display, X = the address of the status unit found.

STATUS UNIT X FAULT

To accept the status units found, **slide the WRITE ENABLE switch**, on the module to which the status units or ancillary boards are connected to write mode. The LCD will then display, X= the address of the status unit found.

STATUS UNIT X
Enter TO ACCEPT

Then press the *Enter* button, the selected status unit or ancillary board will be added to the system and the next unit to be added will be displayed. Press the *Enter* button on the extinguishant module until all of the units have been accepted then slide the *Write Enable* switch to enable mode.

All of the status units found module have now been added and disconnection of any of them will be displayed as a fault on the module and on the detection part of the system. If any status units are disconnected, a Lock Off activated indication will also be displayed at the extinguishant module and all ancillary boards or status units that remain connected. With the *Display Window* Closed, the LCD will display:

REMOTE BUS FAULT

The Status units which are disconnected will have all their indicators flashing. When additional status units are added, these will be shown on the LCD when the system is powered up.

3.1.2. Alternative Configuration of RS485 Circuit.

The Panel is normally configured as per drawing in 10.1 which shows only 1 RS485 cable from the panel. It is possible to have 2 separate cables for the RS485 circuit with the panel effectively in the middle of the circuit rather than at one end. Where this configuration is required the link LK2 must be removed or positioned over 1 pin only. **PANEL MUST BE POWERED DOWN BEFORE ANY CHANGES TO SIGNS.** If process is done with power connected there is a possibility that a short could occur and damage the panel.

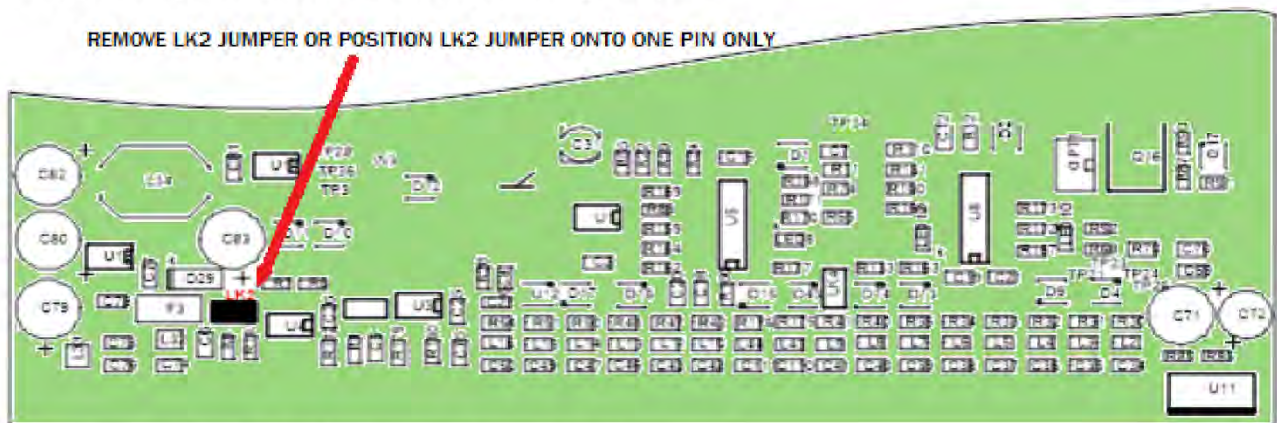

REAR VIEW OF EXTINGUISHING MODULE

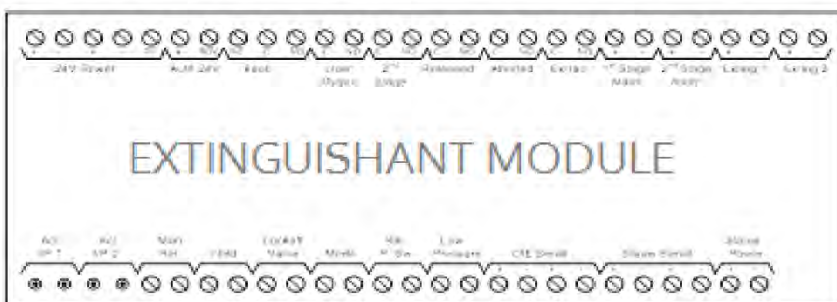

This only required when RS485 cable has Panel position which is not at one end of the circuit.

3.2. Detection zone wiring

The detection zones provide a nominal 24V DC to power compatible conventional detectors and call points. The wiring is monitored for open and short circuit fault conditions. Detection zone circuits must be wired as a single, radial circuit with no spurs or T junctions to enable the monitoring circuit to work correctly.

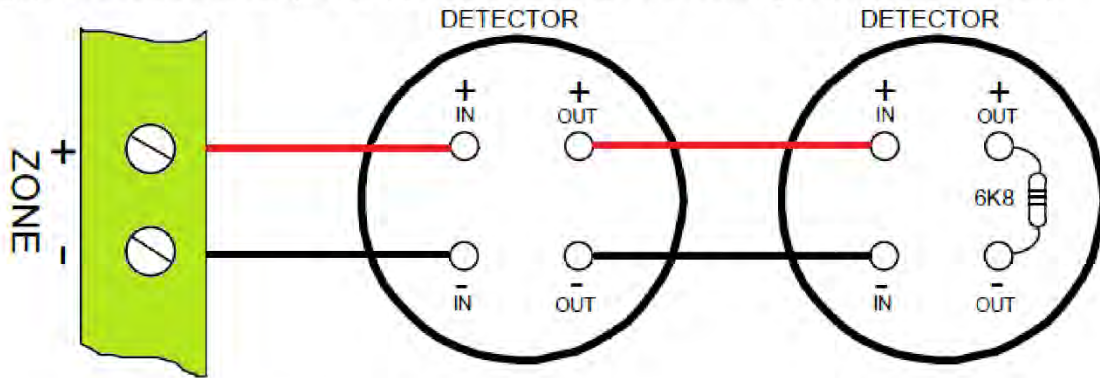

3.3. Sounder circuit wiring

All sounders must be of the polarised type. Sounder circuits are monitored for open and short circuit faults by placing a 10K end of line monitoring resistor across the last device on the circuit.

Sounder circuits must be wired as a single, radial circuit to enable the monitoring circuit to work correctly. A maximum of 1.6 Amps is available for powering sounders with a maximum load of 0.41 Amps on any one circuit.

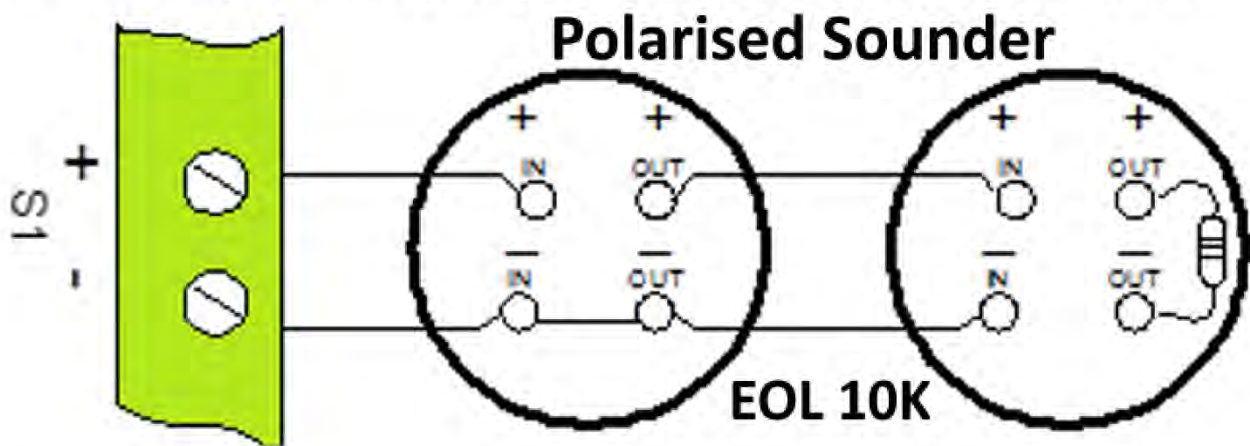

3.4. Thermal Fuse Connection

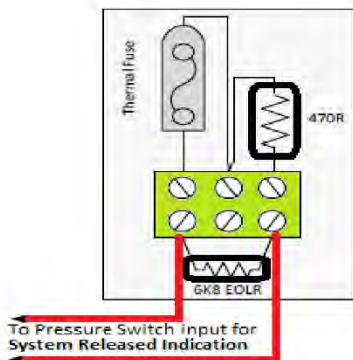

A Thermal Fuse to be connected to the ONE of the FirePro Aerosol Generators in the activation circuit.

The Thermal Fuse allows notification to a control panel that a FirePro unit has activated. It should be installed in accordance with the instructions included in the relevant FirePro document.

Menu setting in the XT card allows for a **normally closed (inverted)** input to be used(10.3.16).

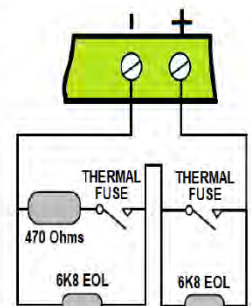

MULTIPLE Thermal Fuses

Connect Thermal Fuse to **Rel.P Switch**

4. Multiway Sequential Activator (FirePro Units)

4.1. Overview

Sequential Activator enables connection of actuator devices. Multiple boards can be connected together to provide control and supervision of up to 40 igniting actuator devices from a single extinguishing control panel circuit.

Where multiple boards are connected, the system comprises one Master board connected to up to 4 Slave boards. MSA boards provide "Activated" and "Fault" indications and optional display boards can be connected to provide indications. A master "Isolate" control with indication of the isolated status is also available Master display boards. All outputs can be isolated such that the system can be tested by observing the "Activated" and "Fault" indications with no danger of operating the igniting actuators. Isolation can be performed via the slide switch mounted on the Master MSA board, or a keyswitch mounted to the panel.

On activation from the control panel, the outputs on each MSA board and subsequent MSA boards operate sequentially such that only one pair of actuator outputs are operated at a time in sequence.

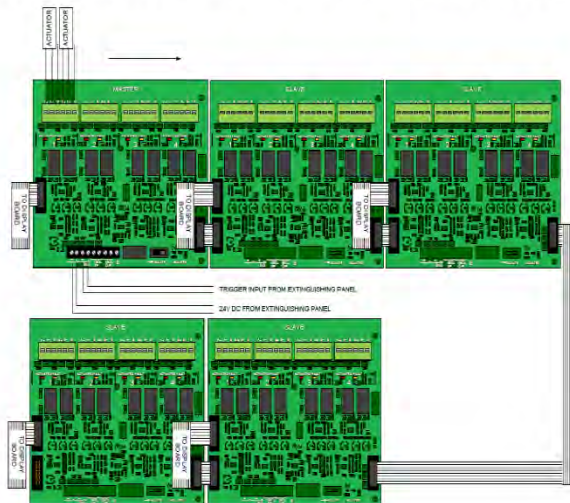

TECHNICAL PARAMETERS	
Ext Input Signal	21-29vDC – Supervised for open and short circuits
Power required	21-29vDC, 100 milliamps
Actuator cable resistance	7 ohms max(A+ to B-)
Actuator resistance	2.6 ohms max per actuator
Actuator output voltage	Follows input voltage – 21-29V
Quiescent current	Ave 10 milliamps per MSA board
Output active time	2.5 to 3 seconds
EOL device	1N4004 diode (Master MSA board, no additional device needed)
Operating temperature	-4C to +40C
Master and Slave size	150mm x 150mm

4.2. Installation

MSA boards must be mounted on metal pillars to a chassis or enclosure that is securely bonded to the earth of the fixed installation in all five mounting positions.

All cabling to the boards should be segregated from any mains cables and wiring to the actuators must be secured to the MSA board with cables ties using the slots provided. Only cables of 2.5mm² or smaller can be connected to the terminals.

Cable resistance can reduce the current available to actuators on long runs. Actuator cable resistance should not exceed the maximum value specified in the technical parameters.

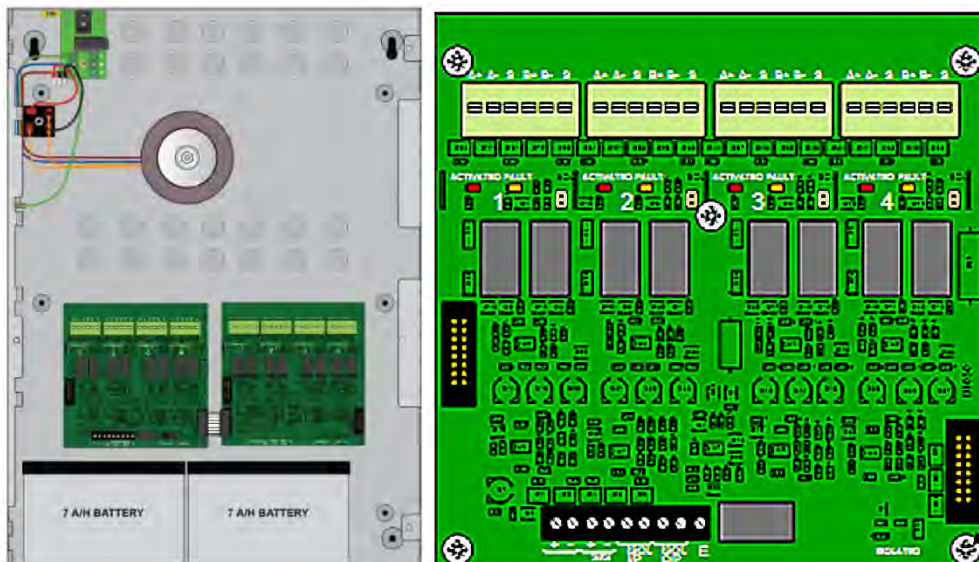

Jumpers are located for each block of terminals. Marked as LK2-5.  These are to be moved or positioned to one PIN only when that block is not being used.

This will indicate that this block is not to be included in the monitored circuit.

(Master shown here)

The signal line from the extinguishing control panel is terminated by a 1N4004 diode which is taken out of circuit when any actuators are disconnected thus signalling a fault condition at the controlling extinguishing panel. A maximum of 4 Slave MSA boards can be connected to a Master MSA board.

4.3. Connection of Aerosol Units to Activation circuit

Quick disconnect terminals are provided in 4 groups of 6 for the connection of actuator devices. To connect the wiring push on the white button on top of the terminal block and insert wire into the aperture making sure that the wire is pushed to the full depth of the aperture. A firm tug on the wire will confirm that it is seated correctly.

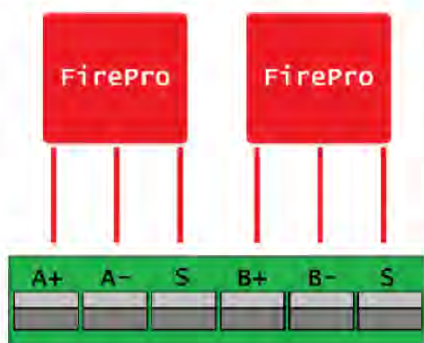

Each FirePro unit is connected directly back to the Sequential Activator as shown. The units are NOT polarity sensitive. ENSURE that earth shield cable is terminated in the terminal marked "S".

Where only one FirePro is required on a circuit a 2R2 3W Wire Wound Surge Resistor must be placed across the other circuit as shown.

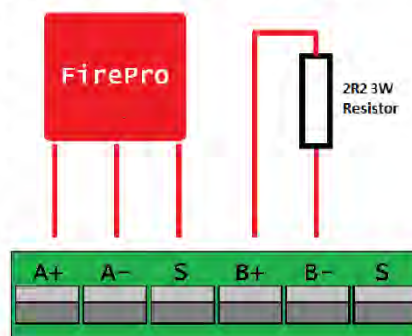

Connections using Splitter Leads



More efficient field wiring may be achieved using Splitter Leads. This allows for a single activation cable to for up to each group of max 4 FirePro units.

The splitter lead is built with a transorb installed which allows for current to be passed for activation under all circumstances.

MAX of 4 Firepro units for each activation Cable. This would require 3 splitter leads.



4.4. Connection to FirePro Units

When constructing leads to the FirePro units the supplied Deutsch Plugs must be used to ensure water-proof connections are made throughout the installation.

1. Cut cable to required length and strip outer insulation to approximately 50mm.
2. Strip inner insulation to approx. 6mm and using a Deutsch Crimping tool, fix pins to the exposed ends of the cable, including the earth.
3. Place heat shrink or rubber boot over the end of the cable. Identify correct socket on plug by the numbers/letter on the side of the plug and push through the gasket at the bottom of the plug until a click is heard and the pin is locked in place.
4. Place the locking wedge inside the plug to ensure pins remain secure. (Male plugs the locking wedge is orange. Female plugs the locking wedge is green)
5. Using the heat shrink and rubber boot, seal the back of the plug.

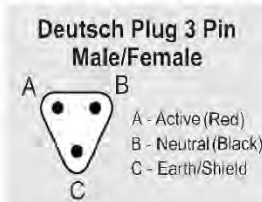

4.5. Input connections

Standard screw terminal connections are provided for connection of the input cables from an extinguishing control panel. These are duplicated to allow the extinguishing circuit to be continued on to other devices if required. A fault will be indicated at the extinguishing control panel if either the trigger input wiring or the 24V power wiring is disconnected from the MSA master board.

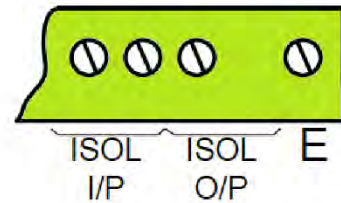
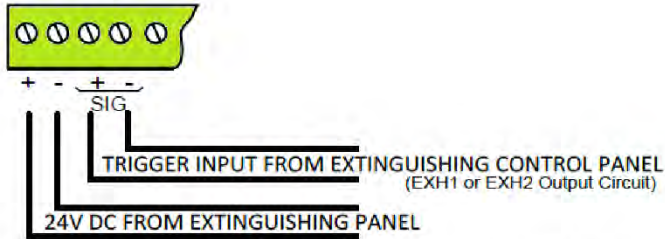

Standard screw terminals are provided for the connection of a remote Isolate switch and indicator. Closing a volt free contact across the ISOL I/P terminals will isolate all outputs. The Isolated condition can be indicated at a remote location via the ISOL O/P volt free terminals.

4.6. Indications

Actuator outputs are supervised for circuit faults and a yellow Fault indicator is provided for each of the 4 dual actuator outputs. This indication is extended to the optional display board.

Activation of each of the 4 dual actuator outputs is indicated by a red Activated indicator which will illuminate as soon as the output operates and remain illuminated until the triggering extinguishing signal is removed. The yellow Fault indicator will illuminate along with the red Activated indicator. This indication is extended to the optional display board. Upon initial power up and after activation Fault LEDs may be illuminated for a few seconds while the system stabilises.

A yellow Isolated indicator is provided which will illuminate upon operation of the onboard Isolate slide switch or the front panel mounted Isolate keyswitch or the ISOL input at the terminal block on the Master MSA.

4.7. Jumper links

End of line monitoring. All boards are supplied with jumper links fitted at position LK1 in the bottom right hand corner of the PCB.

This jumper should be removed and placed on one pin of the 2 pin header only on all boards except the last one fitted to the line. If only one board is fitted the jumper can remain in place. This ensures that the ribbon cable connecting multiple boards is supervised for disconnection and a fault is announced at the extinguishing control panel.

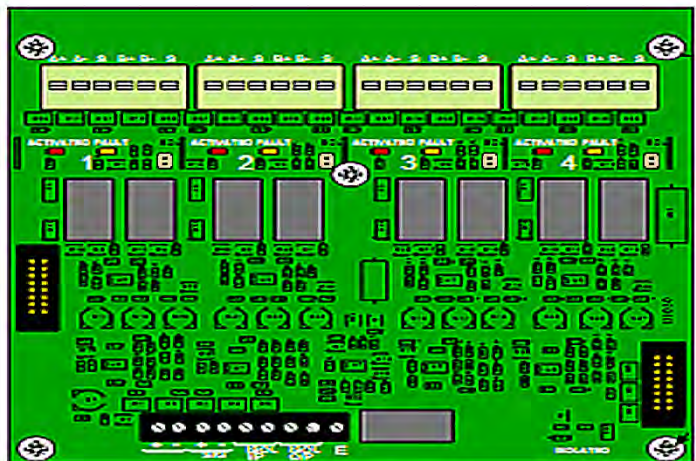

(Slave shown here)

4.8. Fault monitoring links

All boards are supplied with LK2 to LK5 fitted. These links must be fitted to allow the actuator outputs to be supervised. If any of the actuator outputs are not being used the link associated with that actuator output can be removed and placed on one pin of the 2 pin header only.

4.9. Isolate slide switch

As well as the optional front panel keyswitch or a remote isolate switch connected to the screw terminals, Master MSA boards have a slide switch which can be used to isolate all outputs.

Operation of the Isolate switch is accompanied by a yellow LED and allows testing to be performed by activating the control panels releasing output and observing the indicators on the MSA boards illuminating in sequence.

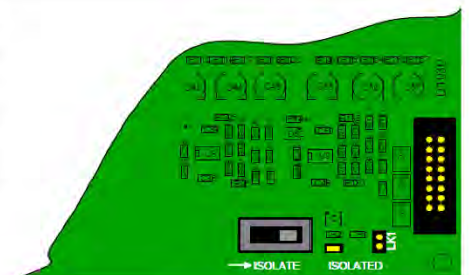

4.10. Display boards

MSA Master and MSA Slave boards have the option for front panel mounted display boards which indicate the Activated and Fault status of the board to which they are connected. The master display board also has an Isolate key switch and Isolated indicator which can be used to isolate all outputs.

The mounting plate for the display board has the facility for a slide in label which can be used to provide a location reference for each of the outputs.

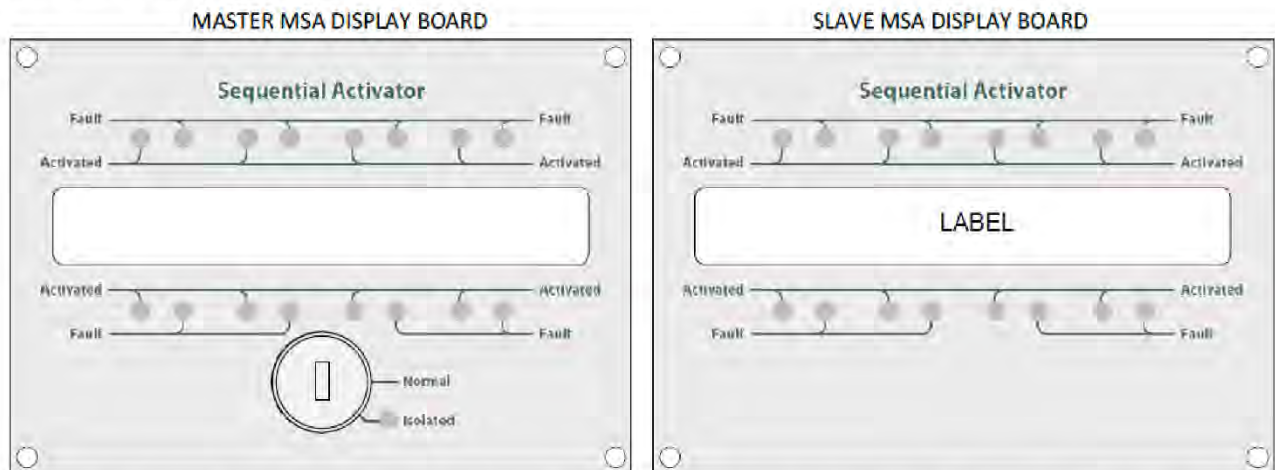

MSA display boards mount to standard MP301TLGT carrier plates and into M2, M3 or M4 enclosures. All display boards have indicators for two MSA boards and connect to the MSA boards via 16 way ribbon cables.

4.11. Setting up extinguishant monitoring circuit

The extinguishant outputs monitor actuator releasing devices. This requires that the outputs be calibrated with the releasing device and the cable to it, fitted as it will be in the working system. The extinguishant monitoring level will be set at approximately 206 but may be between 204 and 208.

Before calibrating the extinguishant outputs ensure that the releasing device is fitted to the cable as shown in section 11.

To change, open the *Display Window* and slide the *Write Enable* switch to the left. Press the *Enter* button on the extinguishant module then press the "-" button until the display shows:

If the parameters of the extinguishant output change e.g. by replacing an actuator, then the extinguishant output monitoring level will need to be "learned". To do this, open the *display window* to put the system into access level 2. The LCD will show:

Enter menu until the LCD displays:

The XXX displayed here is the previous (factory) level to which the monitoring level had been set. Press the *Enter* button. The LCD will now show:

The XXX shown here is the current monitoring level detected on the extinguishant output. Press *Enter* button accept the monitoring level.

Set the monitoring level for output 2 in the same way if it is being used, otherwise switch the *Write Enable* slide switch to the right (off) position and check that an open or short circuit fault on the extinguishant output(s) is detected and shown on the control panel.

NOTE: Value of 255 means that the output is OPEN CIRCUIT. This must be corrected and the circuit re-calibrated.

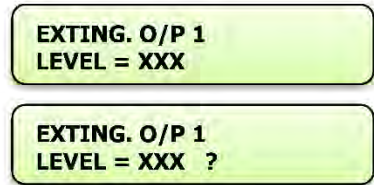

5. Other Connections

5.1. Connection to remote control terminals (not normally used)

Some functions of the control panel can be controlled externally from the panel. These are on the terminals block as follows:

- | | |
|------------------------|---------------------|
| Remote 0V supply – R0V | Silence Alarm – SIL |
| Sound Alarm – AL | Fault – FLT |
| Reset – RST | |

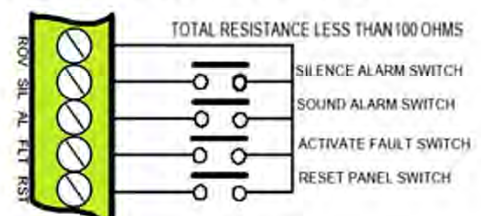

To activate these inputs, the remote 0 Volt (ROV) supply must be connected to the input via a normally open switch or contact and via a resistance of no greater than 100 ohms. All of the remote control inputs are non-latching.

5.2. Aux 24V DC supply

An auxiliary 24V DC supply is provided to enable local signalling or control of ancillary systems such as door release controllers. The terminals for the Aux 24V supply are labelled Aux 24V and ROV. The ROV terminal is the negative terminal and is the same terminal that should be used to switch the remote control terminals.

It is possible to make the ROV terminal pulsing so that by connecting it to the AL terminal via a remote volt-free contact, it can be used to pulse the dedicated sounder circuits in response to a signal from another system for example to give an alert. See programming code 24.

The supply is fitted with an electronic self-resetting fuse to protect the control panel's 24V supply.

Any standing load on the Aux 24V supply must be taken into account when calculating battery standby times as standby time will be significantly affected by even modest standing loads. It is recommended that the Aux24V output is **not** used to power standing loads and not used to supply loads of greater than 500 milliamps.

Where the Aux 24V supply is used to power electromechanical devices such as relays or door retainers it is imperative that a suppression diode is fitted across the coil of the electromechanical device to prevent the generation of high voltage transients back to the control panels power supply.

The Aux 24V DC Supply is not suitable for powering Sigma CP sounder boards or status units.

5.3. Connection to relay contacts

Volt free changeover relay contacts are provided for local control and signalling if required. These contacts are rated for switching signalling circuits only and the maximum ratings listed in Table 1 MUST not be exceeded.

5.3.1. Fault relay (Alarm Module)

The *Fault Relay* is normally energised and will de-energise upon any fault condition on the detection part or the extinguishant part of the control panel including total loss of power.

5.3.2. Fault relay (Extinguishant Module)

These fault relays are normally energised and will de-energise upon any fault condition on the extinguishant module or total loss of power. These relays provide individual fault outputs.

5.3.3. Local fire relay (Alarm Module)

The *Local Fire Relay* will energise upon activation of a fire condition on any of the zones or pressing of the *Sound Alarm* Button on the front panel. The relay will remain activated until the alarm is silenced or the panel is reset. This relay will not operate upon activation of the remote AL input or when a fire condition is triggered on a zone that is in test mode.

5.3.4. Fire relay (Alarm Module)

The *Fire Relay* will energise upon activation of a fire condition on any of the zones. The relay will remain activated until the control panel is reset. This relay will *NOT* operate upon activation of the remote AL input. Individual zones can be configured not to operate the Fire relay by setting configuration options E1 to E8.

5.3.5. First stage alarm relay (Extinguishant Module)

The *First Stage Alarm Relay* will operate upon activation of a zone that has been configured to contribute to the extinguishant release and will de-activate only when the panel has been reset.

This relay will also operate upon activation of the panel mounted or a remote manual release switch. The stage 1 relay output can be disabled at access level 2 via the menus on the Sigma XT module.

5.3.6. Second stage alarm relay (Extinguishant Module)

The *Second Stage Alarm Relay* will operate when the panel is in the activated condition (i.e. the release countdown timer has started) and will de-activate only when the panel has been reset from the released condition.

The stage 2 relay output can be disabled at access level 2 via the menus on the Sigma XT module.

5.3.7. Released relay (Extinguishant Module)

The *Released Relay* on the extinguishant module will operate when the module is in the released condition.

The Released output can be disabled at access level 2 via the menus on the Sigma XT module.

5.3.8. Aborted relay (Extinguishant Module)

The *Aborted Relay* will operate when the panel is in the aborted condition via an abort switch input.

5.3.9. Extract relay (Extinguishant Module)

This provides a means to vent a room of extinguishant gases but prevents the gases from being vented during a discharge. To switch on *Extract Relay*, pen the *display window* press *Enter*. The LCD will show:

Press "-" until the LCD shows:

Press *Enter* to turn ON the *Extract* output and the LCD will show:

TURN OFF
EXTRACT OUTPUT

TURN ON
EXTRACT OUTPUT

5.4. Shutdown Isolation Switch

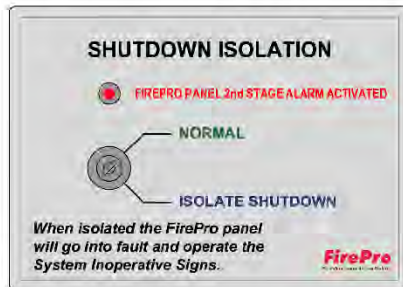

This switch can be installed to "isolate" or disable the shutdown of devices that are connected to the panel. Devices such as Air Conditioners or Sensitive computer devices which are required to be shutdown in a fire, but are not required to be shutdown for Monthly testing purposes. The switch when "isolated" will activate the System Inoperative sign and stop the shutdown signal to the connected devices. This is a powered output to drive a relay.

To install this switch connections as follows:

The *Second Stage Alarm Output* **MUST** be configured to be steady when using

+	From FirePro Panel 2nd Stage Alarm
-	
+	To Server Shutdown Relay 24Vdc 1Amp 10K EOL
-	

this switch. The factory default for the second stage alarm is pulsing.

To change, open the *Display Window* and slide the *Write Enable* switch to the left. Press the *Enter* button on the extinguishant module then press the "+" button until the display shows:

PULSED
ACTIV. ALARMS

To change to steady second stage alarms, press *Enter*. To save, slide the *Write Enable* switch to the right.

STEADY
ACTIV. ALARMS ?

The *Second Stage Alarm Output* will now be steady when the module is activated.

6. Configuring the panel

6.1. Alarm Module

The Alarm Module has 2 or 8 detection zones and has a number of configuration options which can be set at the time of commissioning to suit the requirements of the installation. The configuration options are only available at access level 3 which is accessed by operating the *Write Enable* switch to the left as shown below. When the panel is at access level 3, the buzzer will "pip" three times every few seconds as an indication that it is at this access level.

Configuration options are simple to *Enter* using the codes the table below. When the control panel is at access level 3, the sub-text of the *Mode* and *Select* buttons is used to *Enter* a number using tens (+10) and units (+1).

When the required code number is displayed, pressing the *Enter* button will cause the dot on the units seven segment display to flash. This indicates that a configuration option has been set.

To review which configuration options have been set previously, simply scroll through numbers 1 to 99, A1 to A8, C1 to C8 and E1 to E8 and those with a flashing dot indicate which options have been set.

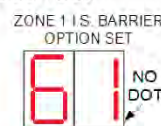
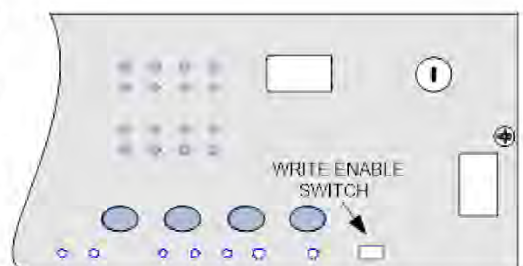

6.2. Extinguishant Module

6.2.1. General Settings

LINKS - The Sigma XT module contains 3 Links.

- LK1 CIE Serial Terminator – This terminates the RS485 comms from the control section
- LK2 Status Serial Terminator – This terminates the RS485 comms to the Status units and Warning Signs
- LK3 PF Input Inversion – Removing this jumper inverts the PF input so that it must be normally connected to 0V for no fault to be present.

PF INPUT - is used to signal a power failure to the XT Module and is active (power fail mode) when connected to 0V. The function of this input can be inverted by the removal of LK3 on the rear of the board.

6.2.2. Language Selection

The module is capable of displaying two languages if factory programmed to do so. The first access level 3 option is to select the local language or the default language (English)

6.2.3. Extinguishant Output mode

The Sigma XT module has two extinguishant outputs. These can be configured to operate together at the same time (common) or be configured as main and reserve outputs. The factory default setting is common.

To change, open the *Display Window* and slide the *Write Enable* switch the left. Press the *Enter* button. The LCD will show:

**EXTING. O/P MODE
= COMMON**

Press the *Enter* button the LCD will show:

Press the *Enter* button to select main/reserve.

**EXTING O/P MODE
MAIN / RESERVE ?**

To save, slide the *Write Enable* switch to the right. When the extinguishant module is activated, only extinguishant output 1 will switch on. There will also be an additional menu item at access level 2 to allow the reserve extinguishant output to be selected.

6.2.4. Configuring the Activation Mode

It is possible to configure the extinguishant modules to be activated by coincidence (any 2 zones in a range of zones) or a single zone in a range of zones. The activation mode is factory set to coincidence.

**ACTIVATION MODE
= COINCIDENCE**

To change, open the *Display Window* and slide the *Write Enable* switch to the left. Press the *Enter* button on the extinguishant module then press the "+" button. The LCD will show:

**ACTIVATION MODE
= SINGLE**

Press the *Enter* button The LCD will show:

6.2.5. User Output Mode

The clean contact User output can be programmed to be activated either when a First Stage Alarm occurs, or the Hold Input is activated. It is usual for this relay to be used as a First Stage Alarm.

**USER OUTPUT.
= STAGE 1**

To change this, open the *Display Window* and slide the *Write Enable* switch to the left. Press the *Enter* button then press the "+" button.

**USER OUTPUT.
= HOLD**

Press the *Enter* button The LCD will show:

**USER OUTPUT.
STAGE 1 ?**

The OUTPUT is now set to HOLD. If the *Enter* button is pressed again The LCD will show:

**USER OUTPUT.
STAGE 1**

Press the *Enter* button and the LCD will show. The output is set to Stage 1

To save the settings, slide the *Write Enable* switch gently to the right. Operation of either a STAGE 1 alarm or the HOLD input, as set above, will result in the activation of the User Output relay.

6.2.6. Configuring the Activation Zones

The extinguishant modules are factory set to be activated by coincidence activation.

This means that on an 8 zone, 4 extinguishant area panel for instance, zones 1 and 2 will be set to activate the extinguishant module at address 1, zones 3 and 4 will be set to activate the extinguishant module at address 2 and so on. This can be changed if required so that any zones can activate the extinguishant module.

To change, open the *Display Window* and slide the *Write Enable* switch to the left. Press the *Enter* button on the extinguishant module and then the "+" button until the display shows, X will be the number of the zone selected to be the first activation zone.

**FIRST ACTIV.
ZONE = X**

**FIRST ACTIV.
ZONE = X ?**

To change use the "+" and "-" buttons to select the required zone number. When the required zone is displayed, press the *Enter* button. The display will show the first activation zone.

Press the *Enter* button and then the "+" button. The display will then show, X will be the last activation zone.

LAST ACTIV.
ZONE = X ?

LAST ACTIV.
ZONE = X

To change use the "+" and "-" buttons to select the require zone number. When the required zone is displayed, press the *Enter* button.

6.2.7. Reset Inhibit Time

This setting can be used to inhibit the reset of the system after it has been activated until there is a signal representing the end of the discharge (a released input) or for an adjustable time period of up to 30 minutes. The factory default for the reset inhibit time is 0.

RESET INHIBIT
TIME = 0 ?

To change, open the *Display Window* and slide the *Write Enable* switch to the left. Press the *Enter* button on the extinguishant module then press the "+" button until the display shows:

RESET INHIBIT
TIME = 0

Press the *Enter* button and the display shows. To change, press the "+" or "-" buttons until the time required is displayed and then press *Enter*. To save, slide the *Write Enable* switch to the right.

6.2.8. Pre-Release Delay Time

This setting allows for a time delay to be set from activation of the extinguishant module to operation of the extinguishant release output. This time may be between 0 and 30 seconds with a maximum of 5 second steps.

The factory default time delay on the Sigma XT extinguishant modules is 30 seconds.

PRE-REL DELAY
TIME = 30 SEC

To change, open the *Display window* and slide the *Write Enable* switch to the left. Press the *Enter* button on the extinguishant module then press the "+" button until the display shows:

PRE-REL DELAY
TIME = 30 ?

Press the *Enter* button and the display will show. To change, press the "+" or "-" buttons until the time required is displayed and then press *Enter*.

6.2.9. Output 2 Delay Time

This setting allows for the EXT 2 output to be fired a short period after EXT 1. This allows for a 'top-up' Extinguishant dump if it is needed.

This time may be between 0 and 10 minutes, available in 1 minute steps.

The factory default setting 0 minutes, meaning that the EXT 2 output fires at the same time as the EXT 1 output.

OUTPUT 2 DELAY
TIME = 0 MIN

The Extinguishant Output Mode must be set to Common.

To change, open the *Display window* and slide the *Write Enable* switch to the left. Press the *Enter* button on the extinguishant module then press the "+" button until the display shows:

OUTPUT 2 DELAY
TIME = 5 MIN ?

Press the *Enter* button and the display will show. To change, press the "+" or "-" buttons until the time required is displayed and then press *Enter*.

To save, slide the *Write Enable* switch to the right.

6.2.10. Extinguishant Release Time

The time that the extinguishant output is active for can be set between 60 and 300 seconds. The factory default time for this is 60 seconds. It is also possible to disable this timer such that the extinguishant outputs remain active until the module is reset. See Release timer menu option section 6.2.15.

To change the *Extinguishant Release Time*, open the *Display Window* and slide the *Write Enable* switch to the left. Press the *Enter* button then press the "+" button until the display shows:

EXTING. RELEASE
TIME = 60 SEC

Press the *Enter* button and the display will show. To change, press the "+" or "-" buttons until the time required is shown then press *Enter*.

EXTING. RELEASE
TIME = 60 ?

6.2.11. Second stage alarm - Pulsing/Continuous

The *Second Stage Alarm Output* can be configured to be steady or pulsing at about 1 second on, 1 second off to suit the desired application. The factory default for the second stage alarm is pulsing.

PULSED
ACTIV. ALARMS

To change, open the *Display Window* and slide the *Write Enable* switch to the left. Press the *Enter* button on the extinguishant module then press the "+" button until the display shows:

STEADY
ACTIV. ALARMS ?

To change to steady second stage alarms, press *Enter* . To save, slide the *Write Enable* switch to the right.

MUST be set to STEADY when using Shutdown Isolation Switch

6.2.12. Released Indication

It is possible to select whether the released indication on a module is operated at the same time as the extinguishant release outputs operate or by operation of a thermal fuse connected to the released thermal fuse input.

AS require indication to be via Thermal Fuse which is factory default.

To change, open the *Display Window* and slide the *Write Enable* switch on the module to be configured gently to the right. Press the *Enter* button on the extinguishant module then press the "+" button until the display shows:

To change press *Enter* . To save, slide the *Write Enable* switch to the right.

RELEASE IND ON
RELEASED INPUT

RELEASED IND ON
EXTING. REL ?

6.2.13. Delay on manual release

The factory default setting for this is for the manual release to have a delay time the same as the pre-release delay.

To change to have no delay when a manual release is operated, open the *Display Window* and slide the *Write Enable* switch to the left. Press the *Enter* button on the extinguishant module then press the "+" button until the display shows:

Press the *Enter* button and the display will show. To change press *Enter*.

To save, slide the *Write Enable* switch to the right. Operation of a manual release will now operate the extinguishant outputs immediately with no delay.

DELAY ON
MANUAL RELEASE

NO DELAY ON
MANUAL RELEASE ?

6.2.14. Pre-Release Delay – Reset/Disable

Once activated, an extinguishant module cannot be reset until after the reset inhibit time has expired and the extinguishant release timer has expired. It is possible to configure the module such that it can be reset during the pre-release delay.

Open the *Display Window* and slide the *Write Enable* switch, on the module to be configured, gently to the left. Press the *Enter* button on the extinguishant module then press the "+" button until the display shows:

Press the *Enter* button to change press *Enter*.

To save, slide the *Write Enable* switch to the right. It will now be possible to reset the module during the pre-release delay but not while the extinguishant outputs have operated until after the expiry on the reset inhibit time.

Note: Disabling the Pre-release delay reset may not comply with the requirements of Australian Standards.

PRE-RELEASE DELAY
RESET DISABLED

PRE-RELEASE DELAY
RESET ENABLED

6.2.15. Release timer (infinite extinguishant duration)

The release timer can be disabled such that once the extinguishant outputs have operated; they remain operated until the system is reset.

To disable, open the *Display Window* and slide the *Write Enable* switch on the module to be configured gently to the left. Press the *Enter* button then press the "-" button until the display shows:

Press the *Enter* button to change to this. To save, slide the *Write Enable* switch to the right. With the release timer disabled, the extinguishant outputs will remain operated until the system is reset.

RELEASE TIMER
ENABLED

RELEASE TIMER
DISABLED ?

6.2.16. ROV Removed on System Reset

This setting should not be changed, and should never be set.

6.2.17. Earth Fault Monitoring – Enable/Disable

The factory default setting is for the earth fault monitoring facility to be enabled.

To disable the earth fault monitoring, open the *Display Window* and slide the *Write Enable* switch to the left. Press the *Enter* button on the extinguishant module then press the "-" button until the display shows:

Press the *Enter* button to change to this. To save the settings, slide the *Write Enable* switch to the right.

EARTH FAULT
ENABLED

EARTH FAULT
DISABLED ?

Once disabled, the Aux 24V output will be removed for a few seconds when the reset button is pressed.

6.2.18. Fault Output – Enable/Disable

The factory default setting is for the fault output relay to be enabled.
Open the *Display Window* and slide the *Write Enable* switch to the left. Press the *Enter* button then press the “-” button until the display shows:
Press the *Enter* button to change. To save, slide the *Write Enable* switch. The fault output relay on the module will now be disabled.
Note: Disabling the fault output does not comply with AS7240-2.

FAULT OUTPUT
ENABLED

FAULT OUTPUT
DISABLED ?

6.2.19. Low Pressure Switch – Normal/Invert

To enable low pressure switches to be used which have normally closed rather than normally open contacts, it is possible to invert the input. The default setting is for the low pressure switch input to use a normally open contact.
To invert the low pressure switch input, open the *Display Window* and slide the *Write Enable* switch to the left. Press the *Enter* button on the extinguishant module then press the “-” button until the display shows:
Press the *Enter* button to change to this.
To save, slide the *Write Enable* switch to the right. The low pressure switch input will now require a normally closed contact via a 470R trigger resistor and 6K8 end of line resistor for correct supervision.

LOW PRESS I/P
MODE = NORMAL

LOW PRESS. I/P
MODE = INVERTED ?

6.2.20. Release Pressure Switch – Normal/Invert

To enable released pressure switches to be used which have normally closed rather than normally open contacts, it is possible to invert the released pressure switch input. The factory default setting is for the pressure switch input to use a normally open contact.
To invert, open the *Display Window* and slide the *Write Enable* switch to the left. Press the *Enter* button on the extinguishant module then press the “-” button until the display shows:
Press the *Enter* button to change to this. **The released pressure switch input needs to be disconnected to bring it into fault before changing from Normal to Inverted or back in order to prevent the input from activating.**
To save, slide the *Write Enable* switch to the right. The released pressure switch input will now require a normally closed contact via a 470R trigger resistor and 6K8 end of line resistor for correct supervision.

RELEASED INPUT
MODE = NORMAL

RELEASED INPUT
MODE – INVERTED ?

7. Panel operation – Access levels 1 and 2

7.1. Normal condition

Under normal conditions and with all modules in Manual & Auto mode, control panels will have only the green, *Power On* LED lit on the Sigma XT detection part and on each of the extinguishing modules. With the *display window* closed, the display on the detection part of the panel will be blank and, the LCDs on the extinguishing modules will show:
Any modules that are in Manual Only mode with have an additional, Manual Only yellow LED lit and their display will show:
The Manual Only LED on the module or ECU/LCS which placed the system in manual mode will be flashing.
The control panel has 3 access levels. Access level 1 is available at all times and allows operation of the *Alarm/Fault Warning Silence* and *Lamp Test* buttons on the detection part of the panel only. Access level 2 is enabled after opening the display window and Access level 3 allows configuration options to be set on both the detection part of the panel and the extinguishant modules following operation of their *respective Write Enable* switches at access level 2 (*the display window is open*).
When the *display window is open* (Access level 2) the display on the detection part of the control panel will show **E I** and the LCDs on the extinguishing modules will show:

AUTO & MANUAL

MANUAL MODE

ACCESS LEVEL 2
MANUAL MODE

7.2. Alarm Module – Access level 2.

7.2.1. Test mode

It is possible to put one or more zones into Test mode. When a zone is in test mode it will self-reset after a few seconds. This enables the system to be tested without having to return to the control panel to reset between each device activation on the zone that is being tested.

To put a zone into test mode, open the *Display Window*.

The 7 segment display will show **t 1**

(test zone 1). To put zone 1 into test mode, press the *Enter* button on the Sigma XT detection part.

The display will now show a flashing dot next to the **t 1** and the yellow Test LED will be lit.

To select further zones to put into test mode, press the *Select* button and then the *Enter* button so that the flashing dot appears next to the selected display e.g. **t 2**.

To remove test mode from a zone, press the *Select* button to reveal any zones that have a flashing dot and then press the *Enter* button to take that zone out of test mode. Once all zones have been taken out of test mode, the yellow, *Test* LED will go off.

7.2.2. Disable zones

It is possible to disable one or more zones. When a zone is disabled it will not report fire or fault conditions. This enables the system to be worked on without false fire or fault conditions being announced.

To disable one or more zones, open the *Display Window*. The 7 segment display will show **t 1** (test zone 1)

Press the *Mode* button and the display will show **d 1**. To disable zone 1 press the *Enter* button. The display will show **d 1** and the yellow *Disablement* LED will be lit.

To select further zones to disable, press the *Select* button and then the *Enter* button so that the flashing dot appears next to the selected display e.g. **d 2**

To remove disablements, press the *Select* button to reveal any zones that have a flashing dot next to the displayed zone number and then press the *Enter* button. Once all zones have been enabled, the yellow, *Disabled* LED will go off.

7.2.3. Disable sounder outputs

The sounder outputs on the detection part of the panel can be disabled if required.

To disable the panel sounder outputs, open the *Display Window*.

The 7 segment display will show **t 1** (test zone 1). Press the *Mode* button until the display shows **db**

Press the *Enter* button. The display will now show **db** the yellow *Disablement* and *Sounder Fault* LEDs will be lit.

To enable the sounder outputs, press the *Mode* button while at Access level 2 (*Display Window open*) and scroll with the mode button until **db** is displayed. Press the *Enter* button. The display will change to **db** and the *Sounder Fault* and *Disablement* LEDs will go OFF if there are no other disablements active on the panel.

7.2.4. Activate delays

It is possible to set delays before sounder outputs will operate (see section 6.1). Before these time delays become effective it is necessary to turn on the *Activate Delays* function.

To do this, open the *Display Window*. The 7 segment display will show **t 1** (test zone 1)

Press the *Mode* button until the display shows **Ad**. Press the *Enter* button, the display will now show **Ad** and the yellow *Alarm Delay* and *Disablement* LEDs will be lit.

To switch off the delay, press the *Mode* button while at Access level 2 (*Display Window open*) and scroll with the *Mode* button until **Ad** is displayed. Press the *Enter* button. The display will change to **Ad** and the *Alarm Delay* and *Disablement* LEDs will go off if there are no other disablements active on the panel.

7.3. Extinguishant modules

7.3.1. Extinguishant System Service Isolate

An Extinguishant System Service Isolate keyswitch is provided on each risk and physically disconnects both contacts of firing line to the extinguishant solenoid or detonator. This minimises the chance of an accidental release of the extinguishant during testing or maintenance, thus allowing the system to be fully functionally tested.

Turning the Extinguishant System Service Isolate keyswitch clockwise will isolate the extinguishant circuit, and a fault is generated and the *Service Isolated* LED is lit.

7.3.2. Extinguishant modules – Menu Access

With the *Display Window* open, all extinguishant modules will display:

ACCESS LEVEL 2
ENTER FOR MENU

7.3.3. Extinguishant release outputs.

Extinguishant release outputs, press the "+" button on the module while at access level 2. The display will show:

DISABLE
EXTING. RELEASE ?

ENABLE
EXTING. RELEASE ?

Press the *Enter* button to select this function. The display will show *Disabled* and the Disabled LED will be lit. Close the *Display Window* to leave the disablement active.

7.3.4. Manual release

Manual release inputs (front panel mounted and remotely connected), press the "+" button on the module while at access level 2 until the module displays:

DISABLE
MANUAL RELEASE ?

ENABLE
MANUAL RELEASE ?

Press the *Enter* button to select this function. The LCD shows *Disabled* and the Disabled LED will be lit. Close the *Display Window* to leave the disablement active.

7.3.5. Disable Stage 1 output

To disable the First Stage relay output, press the "+" button on the module while at access level 2 until the display shows:

DISABLE
STAGE 1 OUTPUT ?

ENABLE
STAGE 1 OUTPUT ?

Press the *Enter* button to select this function. The display will show and the yellow *Disabled* LED will be lit. Close the *Display Window* to leave the disablement active.

7.3.6. Disable Stage 2 output

To disable the Second Stage relay output, press the "+" button on the module while at access level 2 until the display shows:

DISABLE
STAGE 2 OUTPUT ?

ENABLE
STAGE 2 OUTPUT ?

Press the *Enter* button to select this function. The LCD will show and the yellow *Disabled* LED will be lit. Close the *Display Window* to leave the disablement active.

7.3.7. Disable Released output

To disable the Released relay output, press the "+" button on the module while at access level 2 until the display shows:

DISABLE1
RELEASED OUTPUT ?

ENABLE
RELEASED OUTPUT ?

Press the *Enter* button to select this function. The LCD will show and the yellow *Disabled* LED will be lit. Close the *Display Window* to leave the disablement active.

7.3.8. Extract output

To disable Extract relay output, press the "+" button on the module while at access level 2 until the display shows:

DISABLE
EXTRACT OUTPUT ?

Press the *Enter* button to select this function. The LCD will show and the yellow *Disabled* LED will be lit.

Close the *Display Window* to leave the disablement active.

ENABLE
EXTRACT OUTPUT ?

To turn on the extract relay output, press the "-" button on the module while at access level 2 until the display shows:

TURN ON
EXTRACT OUTPUT ?

Press *Enter* to turn ON the *Extract* output. The display will show. Pressing *Enter* again will turn OFF the *Extract* output

Close the *Display Window* to leave the Extract output active Note: the extract output does not turn off when the module is reset.

TURN OFF
EXTRACT OUTPUT ?

7.3.9. Select Reserve Solenoid Output (Configuration Option)

If the extinguishing module is configured for Main/Reserve solenoid operation (See section 15.2.1) then an additional menu option is given to select which output is used.

To turn on the Reserve Solenoid output, press the "+" button on the module while at access level 2 until the display shows:

SELECT RESERVE
EXTING. OUTPUT

Press the *Enter* button to select this function. The display will show:

SELECT MAIN
EXTING. OUTPUT ?

The yellow *Reserve Cylinders* LED indicator on the module will be lit.

Note: This menu option is not shown if the panel is configured to Common Solenoid mode.

7.4. Single Zone and Double Zone Fire Conditions

7.4.1. Single zone Fire condition

Upon receipt of a fire condition by activation of a detector or call point, the *Common Fire* indicator on the detection section will light, the fire buzzer will sound and the zonal *Fire* indicator(s) will flash at around 2Hz.

The fire and local fire relays will also operate and signal any systems to which they are connected.

Any sounders connected to the sounder circuits S1 & S2 on the detection section will operate. These sounders may be silenced by operation of the silence alarm button with the enable keyswitch operated such that the panel is at access level 2.

If the zone that has activated is contributing to the extinguishant release sequence on an extinguishant module and the module is configured for coincidence activation, the *Activated* LED on the module will flash, the *First Stage* relay contact will operate, the *First Stage* sounder output will operate and the display will show:

PREACTIVATED

Pressing the *Silence Alarm* button on the detection section will turn off the sounder outputs on the detection section and the *First Stage Alarm* outputs on the extinguishant module.

7.4.2. Double zone Fire condition

Upon receipt of a second fire condition that contributes to extinguishant release on modules that are switched to Automatic and Manual mode with their Lock Off inputs not active and the Disable Extinguishant function has not been invoked, the detection section will respond as above and extinguishant modules will respond as listed below:

- a) The second stage alarm output will operate. (Sounder circuit S3)
- b) The Second stage contact will operate.
- c) The Activated indicator will operate
- d) The display will indicate ACTIVATED and show the time remaining until release in seconds.
- e) The extinguishant output will operate after the configured delay time and for the configured duration.
- f) The display will show ACTIVATED DISCHARGING for the duration of the release time.

When detection zones have activated and the activated condition is reached (i.e. the *Activated* indicator is lit) it shall not be possible to reset the extinguishant section of the panel until the Reset Inhibit timer has elapsed.

7.5. Silence/sound alarms

The *Silence/Sound alarm* button can only be operated at access level 2. (*Enable Control* keyswitch operated).

To silence the sounders, insert the Enable Control key, turn to the right and press the *Silence/Sound alarm* button. When the sounders have been silenced, the Zone Fire LEDs will change from flashing to a steady state.

Pressing the *Silence/Sound alarm* button whilst the control panel is in this silenced condition will cause the sounders to operate again.

The sounders can be toggled on and off with the *Silence/Sound alarm* button as required.

7.6. Reset

To reset the panel, operate the *Enable Control* keyswitch, then press the *Reset* button. The extinguishant section will reset only after the Reset Inhibit timer has expired once the activated condition has been established.

7.7. Fault Indicators

7.7.1. Detection Zone fault

Removal of a detector from its base or a fault on any of the zone wiring will cause the *Fault* LED and *Zone Fault* LEDs to flash, indicating the zone in which the fault has occurred.

7.7.2. Sounder fault

A fault on the wiring to the detection section sounder circuits will cause the Fault LED to light and the Sounder Fault LED to flash. A fault on the sounder circuits of extinguishant modules (*alarm devices as required by AS7240-1*) will light the Fault LED on the detection section and on the extinguishant module. The extinguishant module will display:

STAGE 1 ALARMS
FAULT

or

STAGE 2 ALARMS
FAULT

7.7.3. Other Faults

POWER - Failure of the mains power or disconnection of the standby battery will cause the *Fault* and *Power Fault* LEDs to light on the detection section indicating an abnormality in the power supply to the control panel. There will be no indication of this condition on the extinguishant modules. Power fault is non-latching and will automatically reset once the fault has been rectified.

SYSTEM FAULT – DETECTION MODULE - The System Fault and general fault LEDs will light if the configuration memory has not been set or has become corrupted. System fault is non-latching and will automatically reset once the configuration has been rectified.

SYSTEM FAULT – EXTINGUISHING MODULE - The System Fault and general fault LEDs will light if the configuration memory has not been set or has become corrupted. System fault is non-latching and will automatically reset once the configuration has been rectified.

GENERAL FAULT - The General fault LED will be illuminate under any fault condition. This LED will also light if the *Write Enable* switch has been left in the access level 3 position and the *Display Window is closed (Access Level 1)*.

CONFIG WP FAULT – EXTINGUISHING MODULE - The *Write Enable* switch on the Extinguishant Module has been left in the access level 3 position and the *Display Window is closed (Access Level 1)*.

7.8. Lamp test

All LED indicators on the panel can be tested at any time by pressing the *Lamp Test* button on the Detection part. Indicators on individual extinguishant modules can be lamp tested by holding down the *Exit* button for more than 2 seconds.

7.9. Lock Off condition

Activation of the Lock Off input or a fault on the monitored wiring of the Lock Off circuit on a module or at a remotely mounted status unit will cause the Lock Off Activated indicator to light on the module and on any status units or ancillary boards connected to it.

If the extinguishant module is in the Activated condition and the pre-release timer is running then the extinguishant release sequence will be halted and the pulsing, Second stage sounders shall change to 1 second on, 2 seconds off.

Release of the Lock Off input will re-start the pre-release timer from maximum.

7.10. Released condition

The released pressure switch input will be connected to a thermal fuse mounted on one the aerosol generator(s) which operates when the extinguishant has been released. This will activate the released indicator on the control panel. If the extinguishant has been released by mechanical means i.e. the control panel is not in the activated condition, operation of the thermal fuse input will establish the Released condition. (See 7.6 & 13.3.12)

7.11. Low pressure switch

This is not used in a FirePro Aerosol Suppression System. The low pressure switch input will be connected to a pressure switch on the extinguishant cylinder which will operate if the pressure in the cylinder falls below a set point. This will happen after the extinguishant has been released but may happen before release through a leak. The fault LED will light and the buzzer will sound when this input is operated.

7.12. Manual only mode

The mode of the system can be toggled between Manual Only and Automatic & Manual by operating the Mode Select pushbutton on the modules. The safety cap must be lifted upwards before the pushbutton can be operated. When a module is in Manual Only mode, the extinguishant cannot be released by the operation of automatic detectors.

The mode can also be changed to manual by the external mode select input or a Mode Select pushbutton on a status unit. Any mode select input that is switched to Manual only mode will override any modules switched to Automatic and Manual mode. All inputs must be switched to Manual and Automatic mode for a module to be in Automatic and Manual mode.

7.13. Manual Release

Extinguishant modules may be activated by Manual release inputs via the manual release control on the front of each module, a remotely mounted Manual release control connected the monitored manual release inputs or by a manual release control mounted on a status unit.

Activation of any of these Manual release controls will immediately activate the extinguishant module and begin the pre-release timer if the module is configured to have a time delay for Manual release inputs.

7.14. Abort input

Each module has the facility for connection of an Abort control. Operation of the Abort input or a fault on the monitored wiring of the Abort circuit during the pre-release delay time or before activation will light the Abort indicator on the module and the extinguishant release timer will be cancelled i.e. the extinguishant will not be released. The module can be immediately reset from this condition.

8. FPC-2 Sub Panel

The FPC-2 Panel enables monitoring detection and automatic extinguishing of a fire in various detection systems on one zone. This Panel is to be used in unmanned spaces only and can report events back to a FIP.

The panel will support up to 4 FirePro® generators. All circuits are monitored. The FPC-2 requires a 24V DC power supply from FIP. There is a single detection Zone and the FPC-2 has automatic activation of extinguishing agent.

Detailed information for connection of FPC-2 is shown in FPC-2 Manual.



9. Internal Controls and Fault Indicators (Troubleshooting)

9.1. Fire Alarm Module

9.1.1. Numerical Display – Detection and Alarm Panel

Under normal operation, this display will indicate the address of the remote board when a fault occurs on that board, or when a board goes missing.

The first section is the board type and the second is its address.

X represents the address 1 to 7

'OX' – Fault on Output board (Relay or AIM module)

'vX' – Fault on Extinguishant module. Refer to Extinguishant module display.

9.1.2. Indicators – Detection and Alarm Panel

MAINS FAIL - Indicates that the 230V AC supply is not present and the system is running on standby batteries. If there is not a power cut, check the panels mains fuse.

BATT FAIL - Indicates that the standby battery has become disconnected or that the charging circuit of the control panel has a high resistance or has failed. Check that both batteries are connected and linked together. Test the battery. Disconnect the battery and ensure that 28 Volts can be measured on battery charger leads.

CPU FAULT - Indicates that the central processor unit has failed to correctly execute code and has been re-started by the system watchdog. The *Watchdog Reset* switch must be pressed to clear the *CPU Fault* condition. If system does not return to normal after the *Watchdog Reset* switch is pressed then the panel is probably damaged and the circuit board needs replacing.

AUX 24V FAULT - The Aux 24V and R0V terminals provide a 500 milliamp, 24V DC power supply for power fire alarm ancillary equipment. This LED indicates that fuse protecting the R0V output has operated and the rating of this output has been exceeded. The fuse is a self-resetting type and the supply will resume when the fault condition is removed.

BATT LOW - Illuminates when the system is running on batteries and the battery voltage is lower than 21V +/- 2% (the minimum battery voltage).

COMMS FAULT - Indicates that communication has been lost with an extinguishant module. Check for comms fault at all extinguishant modules identify the source of the problem.

EARTH FAULT - Indicates that part of the system wiring is connected to earth. Remove all system wiring and re-connect cables one at a time until the earth fault returns.

SYS FUSE FAULT - Indicates that the total power rating of the power supply has been exceeded and that the system fuse has come into operation. Remove and review all loads and re-connect one at a time until over rated circuit trips fuse to identify troublesome circuit.

S1 FAULT and S2 FAULT - Indicates a short or open circuit on sounder outputs. Remove wiring and refit end of line resistors. Check sounder circuit wiring.

9.1.3. Watchdog reset

If for any reason the microprocessor in the Fire Alarm Module of the control panel fails to carry out its operation correctly it will attempt to restart. This process is called a "watchdog" and the control panel must record and indicate these events. If a watchdog event occurs, the fire alarm module will show the Fault and System Fault LEDs on the front panel, the CPU fault LED inside the panel will light and the buzzer will sound. This fault can only be cleared by pressing the Watchdog Reset button on the PCB inside the control panel. The control panel buzzer will continue to sound until the watchdog activation is reset.

9.1.4. Processor reset

Once started, the microprocessor controlling the fire alarm module of the panel should continue to run continuously without interruption. If the microprocessor fails to run correctly it can be reset by pressing the Processor Reset button on the PCB inside the control panel.

This should not normally be necessary but should be done as a matter of course if the system is behaving abnormally. The system should resume normal operation within a couple of seconds of pressing the processor reset button. It will be necessary to press the Watchdog Reset button a few seconds after pressing the Processor Reset button to clear the Watchdog indication and buzzer.

9.1.5. Write enable switch

To protect the configuration memory of the panel while it is running normally the *Write Enable* switch is provided. The memory *Write Enable* switch must be switched on before any changes can be made to the configuration. The *Write Enable* switch is quite fragile and should be operated with care.



9.2. Extinguishant Module

9.2.1. Indicators - Extinguishant modules

WATCHDOG - Indicates that the processor has failed to correctly execute code and has been re-started by the watchdog circuit. The watchdog reset switch must be pressed to clear the Watchdog fault condition. If system does not return to normal, then the module is probably damaged and needs the circuit board replacing.

SYSTEM FUSE - Indicates that the modules main fuse has been overloaded and the module is shut down. Remove and review all loads then re-connect one at a time.

MAN. RELEASE - Indicates that either the front panel mounted or a remotely connected Manual release control has been operated. This indication can only be cleared by power cycling the module.

REMOTE BUS FAULT (on display) - Indicates that one or more devices on the remote serial bus is not responding either through a disconnection or failure. Any disconnected status unit will have all indicators and LED displays flashing 88. Any disconnected ancillary board will have its COMMS LED illuminated.

First place to check are the warning signs and LCS modules. Make sure that addresses are different, and that status cabling is correct.

OUTPUT UNIT FAULT (on display) - On panel initialisation after power up or a processor reset indicates that a warning sign or ancillary board has been added or removed from the communications bus. During normal operation indicates that a warning sign or ancillary board has had a processor failure.

STATUS UNIT FAULT (on display) - On panel initialisation after power up or a processor reset indicates that a status unit has been added or removed from the communications bus. During normal operation indicates that a status unit has had a processor failure.

9.2.2. Watchdog reset

If the microprocessor on an extinguishant module fails to carry out its operation correctly it will attempt to restart. If a watchdog event occurs, the Extinguishant module will show *Fault* and *System Fault* LEDs on the front panel,

the detection part of the panel will show a fault and the buzzer will sound and the display on the Extinguishant module will show CPU fault.

This fault can only be cleared by pressing the Watchdog Reset button on the Extinguishant module. The control panel buzzer will continue to sound until the watchdog activation is reset.

9.2.3. Watchdog reset switch

If for any reason the microprocessor in the control panel fails to carry out its operation correctly it will attempt to restart itself. This process is called a “watchdog” and the control panel must record and indicate these events. If a watchdog event occurs, the control panel will show the *Fault* and *System Fault* LEDs on the front panel, the *CPU Fault* LED inside the panel. This fault can only be cleared by pressing the *Watchdog Reset* button on the PCB inside the control panel. The control panel buzzer cannot be silenced and will continue to sound until the watchdog activation is reset.

9.2.4. Processor reset

If the microprocessor on an Extinguishant module fails to run correctly it can be reset by pressing the Processor Reset button on the PCB inside the control panel. This should not normally be necessary but should be done as a matter of course if the system is behaving abnormally. The system should resume normal operation within a couple of seconds of pressing the processor reset button.

9.2.5. Processor reset switch

Once started, the microprocessor controlling the panel should continue to run continuously without interruption. If the microprocessor fails to run correctly it can be reset by pressing the *Processor Reset* button on the PCB inside the control panel. This should not normally be necessary but should be done as a matter of course if the system is behaving abnormally. The system should resume normal operation within a couple of seconds of pressing the *Processor Reset* button. Note: A *Watchdog Reset* should always be performed following a *Processor Reset*.

9.2.6. Terminate extinguishant

Once the extinguishant outputs have been operated they cannot be switched off until after the reset inhibit timer has elapsed. For test purposes a terminate extinguishant button is provided which will terminate operation of the extinguishant outputs and allow the system to be reset.

9.2.7. Address switch

Extinguishant modules are connected to the serial bus of the Sigma XT detection part of the control panel and each module must be allocated an address between 1 and 7 using the binary coded DIP switch.

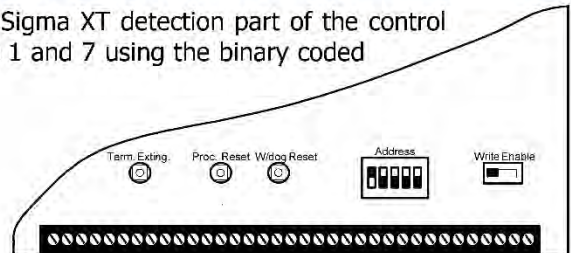

10. Power Supply

To power up the panel Main Supply must be connected. Following power up the panel will maintain all functions via the internal Backup Batteries. The panel maintains a monitoring function over the condition of the batteries – when batteries become due for replacement a batteries fault is displayed.

The control panel requires a 230V (+10%/-15%), 50/60Hz, AC mains power supply which connects to the fused terminal block labelled “230V”.

The maximum loading on the power supply must be carefully considered when connecting externally powered equipment..

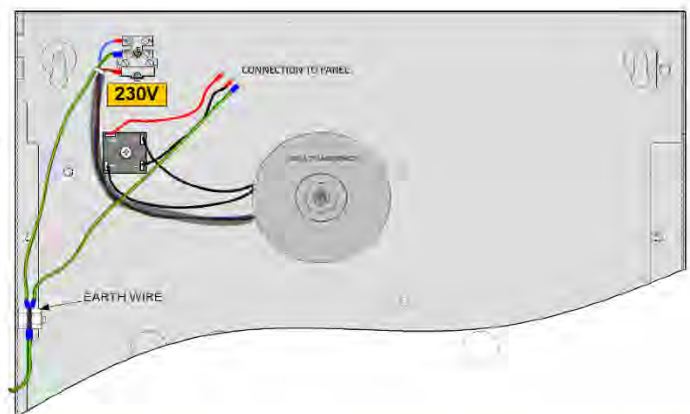

Fuses

3A power supply - 20mm, F1.6A L250V

4A power supply - 20mm T2A L250V.

Exceeding the maximum power supply rating may cause a fuse or other protective device to operate and render the equipment inoperative until the fuse is replaced or protective devices are reset.

Current in milliamps	SIGMA-2 Zone		SIGMA-8 Zone	
	Quiesant	Alarm	Quiesant	Alarm
Alarm Module	65 mA	100 mA	90 mA	150 mA
Extinguishing Module	54 mA	105 mA	54 mA	105 mA
Sequential Activator – FirePro Systems	10 mA	100 mA	10 mA	100 mA
Warning Signs	20 mA	140 mA	20 mA	140 mA
Local Control Stations	60 mA	70 mA	60 mA	70 mA

The output voltage of the power supply is 18-30V depending on mains and battery condition and the total current rating is either 3A or 4A depending on the model. The incoming mains cable should be routed away from other lower voltage wiring by a distance of at least 50mm. Mains wiring MUST include an earth conductor, which is securely bonded to the building earth and should enter the enclosure as close as possible to the mains terminal block.

Maximum current drawn from the batteries when the main power source is disconnected is 3 Amps. When the batteries are discharged to a level at which a low battery indication is given, the *Batt Fail* indicator will also be lit.

WRONGLY CONNECTED BATTERIES COULD CAUSE DAMAGE TO THE CONTROL PANEL.

Battery leads are supplied wired to the power supply along with a link to connect the two batteries together. It is most important that the polarity of the batteries is carefully observed when connecting

The panels have a **temperature compensation sensor** held in place on the power supply chassis with adhesive tape. The tip of the sensor must be fitted to one of the batteries with the tape supplied for correct temperature compensation.

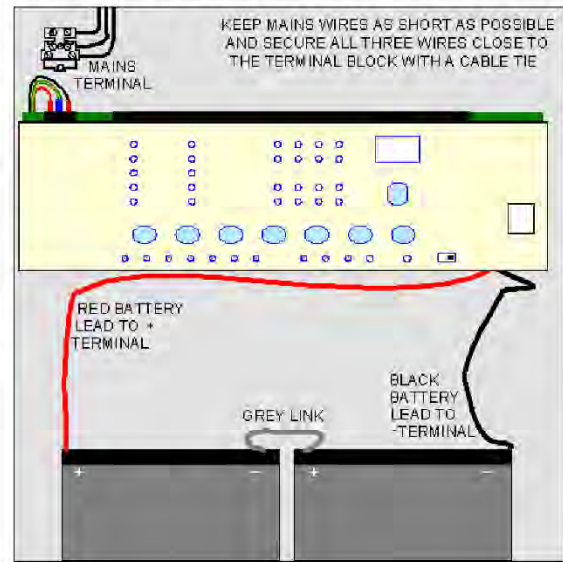

11. Maintenance

Sigma XT control panels do not require any specific maintenance, should the control panel become dirty it can be wiped over with a damp cloth and should then be dried with a dry, lint free cloth. Detergents or solvents should not be used to clean the panel and care must be taken that water does not *Enter* the enclosure.

The control panel contains sealed lead acid batteries to provide standby power in the event of a mains failure. Batteries have a life expectancy of around 2 years

Testing of the extinguishant system should only be carried out by trained personnel and must be done with appropriate isolation measures in place to ensure that accidental discharge of the extinguishant agent is avoided and any malfunction should be reported to the fire alarm maintenance company immediately.

12. Technical specification

Electrical Specifications		
Mains supply	230V AC +10% - 15% (100 Watts maximum)	
Mains supply fuse	1.6Amp (F1.6A L250V)	Replace only with similar type
Power supply rating	3 Amps total including battery charge 28V +/- 2V	
Maximum ripple current	1.5 Volts	
Output voltage	18.5 to 29V DC +/- 2%	
I _{max a}	400 milliamps	
I _{max b}	2.3 Amps	
I _{min}	0.065A	
Battery type (Yuasa NP)	Two 12 Volt sealed lead acid (7Ah maximum)	See Table 2 for capacities
Battery charge voltage	27.6VDC nominal (temperature compensated)	See Table 3
Battery charge current	0.7A maximum	
Battery lead fuse	20mm, 3.15A glass	Replace only with the same type
Battery high impedance warning (R _{imax})	1.35 ohms max	
Low battery voltage indication	21V +/- 2%	

Low battery shut off voltage	18.5V +/- 2%	
Max current draw from batteries	3 Amps	With main power disconnected
ROV output	Fused with electronic fuse	
Dedicated sounder outputs	24V Fused at 500mA with electronic fuse	1.6 Amp total load over <u>all</u> circuits
Zonal sounder outputs		
Aux 24V output (detection module)	Fused at 500mA with electronic fuse	200 mA max continuous load 18.5 to 30V DC
Aux 24V output (Extinguishant module)		
First and Second stage Sounder output	18 to 30V DC Fused at 1A with electronic fuse	1.0 Amp total load over all circuits Voltage reversing DC
Fault relay contact rating	30VDC 1A Amp maximum for each	Max ratings not to be exceeded
Fire relay contact rating		
Local fire relay contact rating		
First stage contact rating	5 to 30VDC 1A Amp maximum for each Volt free changeover contact	Max ratings not to be exceeded
Second stage contact rating		
Extract contact rating		
Zone quiescent current	1.6mA maximum	See Table 4 for detector types
Terminal capacity	0.5mm ² to 2.5mm ² solid or stranded wire	
Number of detectors per zone	> 20	Dependent on type
Number of sounders per circuit	Dependent on type and current consumption	See Table 6 for sounder types
Detection circuit end of line	6K8 5% ½ Watt resistor	Supplied in terminals
Monitored input end of line	6K8 +/- 5% ½ Watt resistor	
Sounder circuit end of line	10K 5% ½ Watt resistor	
Extinguishant output end of line	1N4004 Diode	
No. of detection circuits		Dependent on model
No. of sounder outputs	2 (plus one per zone on T models)	
Extinguishant release output	18 to 30V DC. Fused at 1 Amp	1 A maximum load –for 5 minutes 3 A for 20 milliseconds
Extinguishant release delay	Adjustable 0 to 60 seconds (+/- 10%)	5 second steps
Extinguishant release duration	Adjustable 60 to 300 seconds	5 second steps
SIL, AL, FLT, RST inputs	Switched -ve, max resistance 100 Ohms	
Zone normal threshold	8K ohm TO 1K ohm	
Detector alarm threshold	999 ohms to 400 ohms	
Call point alarm threshold	399 ohms to 100 ohms	
Short circuit threshold	99 ohms to 0 ohms	
Head removal condition	15.5 to 17.5 volts	Zener clamp detector base to be used
Cabling	FP200 or equivalent (maximum capacitance 1uF maximum inductance 1 millihenry)	Metal cable glands must be used
Monitored inputs normal threshold (Allowable EOL)	10K ohm to 2K ohm	
Monitored inputs alarm threshold	2K ohms to 150 ohms +/- 5%	
Monitored inputs Short circuit threshold	140 ohms to 0 ohms +/- 5%	
Status unit/Ancillary board connection	Two wire RS485 (EIA-485 specification)	Max 7 units per area- RS485 cable.
Status unit power output	18 - 30V DC, Fused 500mA with electronic fuse	250 mA max load. Max 3 modules
Sequential Activator – FirePro Units	Normal Resistance for FP Unit 2.8R Nominal Short Circuit: 1R ± 25% 20 deg C Nominal Open Circuit: 13R +15% -5% 20 deg C	Min allowable FP resistance across temp to 40 deg C: 3R. When only one FP, a 2.2R 3W resistor in line.

Battery Charge versus Temperature

Temp °C	Battery Charge	Temp °C	Battery Charge	Temp °C	Battery Charge
0	29.2V	10	28.56V	20	27.99V
		30	27.55V	40	27.13V

Compatible Detectors

Model	Type	Manufacturer	Maximum Number per zone
SLV-AS	OPTICAL	HOCHIKI	40
DCD-A	HEAT	HOCHIKI	40
DCD-C	HEAT	HOCHIKI	35
DFJ-60B	HEAT	HOCHIKI	40
DFJ-90D	HEAT	HOCHIKI	35
DFG-60BLKJ	HEAT	HOCHIKI	40
DRD-AS	FLAME	HOCHIKI	25
SPC-AS	BEAM	HOCHIKI	6

13. Commissioning Instructions and Record of Configuration

When power is applied, if all connections are correct, only the green Power On and either the Automatic and Manual or Manual Only indicators should be lit. Use the Table below to record the configuration codes that have been set on the control panel for future reference.

ALARM MODULE			
CODE	FUNCTION	COMMENTS	SET
00	SOUNDER DELAY TIME = 30 SECONDS	Sets the time delay before sounders operate in combination with configuration codes 31 to 48 and access level 2 function AD.	
01	SOUNDER DELAY TIME = 1 MINUTE		
02	SOUNDER DELAY TIME = 2 MINUTES		
03	SOUNDER DELAY TIME = 3 MINUTES		
04	SOUNDER DELAY TIME = 4 MINUTES		
05	SOUNDER DELAY TIME = 5 MINUTES		
06	SOUNDER DELAY TIME = 6 MINUTES		
07	SOUNDER DELAY TIME = 7 MINUTES		
08	SOUNDER DELAY TIME = 8 MINUTES		
09	SOUNDER DELAY TIME = 9 MINUTES		
10	COMMON ALARM MODE	All sounders operate upon any fire condition	
11	TWO-STAGE ALARM MODE	Continuous sounders in activated zone, pulsing elsewhere	
12	ZONED ALARM MODE	Only sounders connected to zone in alarm operate	
21*	DISABLE FIRE BUZZER	Buzzer will not operate on fire condition	
22*	DISABLE FAULT OUTPUT	Fault relay will not operate except upon total power failure	
23	DISABLE EARTH FAULT MONITORING		
24	PULSED REMOTE CONTROL OUTPUT	Aux 24V supply pulses 1 sec on/1 sec off	
25	ENABLE Sounders on Detection CIRCUITS	WHERE two wire "T" series detectors and Sirens on same cables)	
26	DISABLE FIRE OUTPUT	Fire relay will not operate upon any alarm	
27	DO NOT CHANGE	Do not Change	
28	INDICATE CALL POINT ACTIVATION - Activation of a call point with a 270R resistance fitted is indicated by a flashing zone indicator and "Pu" on the 7 segment display. Activation of a detector will be indicated by a steady zone indicator and nothing on the 7 segment display		
29	DONT RE-SOUND ALARMS From ANOTHER ZONE - Silenced sounders wont re-sound if further zone activate.		
31	ZONE 1 ALARM from DETECTOR DELAYED	Sounder outputs will be delayed by time set at options 0-9 when selected zone(s) triggered by detector only. Note access level 2 function Ad must be set for this to take effect.	
32	ZONE 2 ALARM from DETECTOR DELAYED		
33	ZONE 3 ALARM from DETECTOR DELAYED		
34	ZONE 4 ALARM from DETECTOR DELAYED		
35	ZONE 5 ALARM from DETECTOR DELAYED		
36	ZONE 6 ALARM from DETECTOR DELAYED		
37	ZONE 7 ALARM from DETECTOR DELAYED		
38	ZONE 8 ALARM from DETECTOR DELAYED		
41	ZONE 1 ALARM from CALL POINT DELAYED	Sounder outputs will be delayed by time set at options 0-9 when selected zone(s) triggered by call point only. Note access level 2 function Ad must be set for this to take effect.	
42	ZONE 2 ALARM from CALL POINT DELAYED		
43	ZONE 3 ALARM from CALL POINT DELAYED		
44	ZONE 4 ALARM from CALL POINT DELAYED		
45	ZONE 5 ALARM from CALL POINT DELAYED		
46	ZONE 6 ALARM from CALL POINT DELAYED		
47	ZONE 7 ALARM from CALL POINT DELAYED		
48	ZONE 8 ALARM from CALL POINT DELAYED		
51	COINCIDENCE ZONE 1	Zone contributes to ancillary board coincidence O/P. Any number of zones can be selected to contribute.	
52	COINCIDENCE ZONE 2		
53	COINCIDENCE ZONE 3		
54	COINCIDENCE ZONE 4		
55	COINCIDENCE ZONE 5		
56	COINCIDENCE ZONE 6		
57	COINCIDENCE ZONE 7		
58	COINCIDENCE ZONE 8		
61	CONFIGURE Z1 FOR I.S BARRIER	Detection threshold changed for use with IS barrier	
62	CONFIGURE Z2 FOR I.S BARRIER		
63	CONFIGURE Z3 FOR I.S BARRIER		
64	CONFIGURE Z4 FOR I.S BARRIER		
65	CONFIGURE Z5 FOR I.S BARRIER		

66	CONFIGURE Z6 FOR I.S BARRIER		
67	CONFIGURE Z7 FOR I.S BARRIER		
68	CONFIGURE Z8 FOR I.S BARRIER		
71*	ZONE 1 SHORT CIRCUIT INDICATES ALARM	Changes the trigger threshold of the zone so that the control panel can be used on older systems that had no short circuit monitoring. DOES NOT COMPLY WITH AS7240.2 THIS change required when connecting to FPC2 Module	
72*	ZONE 2 SHORT CIRCUIT INDICATES ALARM		
73*	ZONE 3 SHORT CIRCUIT INDICATES ALARM		
74*	ZONE 4 SHORT CIRCUIT INDICATES ALARM		
75*	ZONE 5 SHORT CIRCUIT INDICATES ALARM		
76*	ZONE 6 SHORT CIRCUIT INDICATES ALARM		
77*	ZONE 7 SHORT CIRCUIT INDICATES ALARM		
78*	ZONE 8 SHORT CIRCUIT INDICATES ALARM		
81*	ZONE 1 NON-LATCHING	Sets the zone to self-resetting so can be used to receive signals from other systems and will reset when input is removed. Note: Can take up to 20 secs for zone to resetlf when sounders are operating. DOES NOT COMPLY WITH AS7240.2	
82*	ZONE 2 NON-LATCHING		
83*	ZONE 3 NON-LATCHING		
84*	ZONE 4 NON-LATCHING		
85*	ZONE 5 NON-LATCHING		
86*	ZONE 6 NON-LATCHING		
87*	ZONE 7 NON-LATCHING		
88*	ZONE 8 NON-LATCHING		
91	ZONE 1 DOES NOT SOUND ALARMS	Prevents the zone from operating the two common sounder outputs.	
92	ZONE 2 DOES NOT SOUND ALARMS		
93	ZONE 3 DOES NOT SOUND ALARMS		
94	ZONE 4 DOES NOT SOUND ALARMS		
95	ZONE 5 DOES NOT SOUND ALARMS		
96	ZONE 6 DOES NOT SOUND ALARMS		
97	ZONE 7 DOES NOT SOUND ALARMS		
98	ZONE 8 DOES NOT SOUND ALARMS		
A1*	ZONE 1 ANY ALARM DELAYED	Zone needs to be triggered for 30 secs continuously before an alarm is generated. DOES NOT COMPLY WITH AS7240.2	
A2*	ZONE 2 ANY ALARM DELAYED		
A3*	ZONE 3 ANY ALARM DELAYED		
A4*	ZONE 4 ANY ALARM DELAYED		
A5*	ZONE 5 ANY ALARM DELAYED		
A6*	ZONE 6 ANY ALARM DELAYED		
A7*	ZONE 7 ANY ALARM DELAYED		
A8*	ZONE 8 ANY ALARM DELAYED		
C1	ZONE 1 SOUNDERS INHIBITED	Not Used Enables individual zones to be configured not to operate zonal sounders. On 2 wire "T" series panels this enables individual zones to be configured for use with conventional (non-savwire) detector bases.	
C2	ZONE 2 SOUNDERS INHIBITED		
C3	ZONE 3 SOUNDERS INHIBITED		
C4	ZONE 4 SOUNDERS INHIBITED		
C5	ZONE 5 SOUNDERS INHIBITED		
C6	ZONE 6 SOUNDERS INHIBITED		
C7	ZONE 7 SOUNDERS INHIBITED		
C8	ZONE 8 SOUNDERS INHIBITED		
E1*	ZONE 1 WILL NOT OPERATE FIRE RELAY	Enables individual zones to be selected to not operate the fire relay. This is sometimes combined with the non-latching function to prevent ring around on interconnected panels DOES NOT COMPLY WITH AS7240.2	
E2*	ZONE 2 WILL NOT OPERATE FIRE RELAY		
E3*	ZONE 3 WILL NOT OPERATE FIRE RELAY		
E4*	ZONE 4 WILL NOT OPERATE FIRE RELAY		
E5*	ZONE 5 WILL NOT OPERATE FIRE RELAY		
E6*	ZONE 6 WILL NOT OPERATE FIRE RELAY		
E7*	ZONE 7 WILL NOT OPERATE FIRE RELAY		
E8*	ZONE 8 WILL NOT OPERATE FIRE RELAY		
Extinguishant Module			
CONFIGURATION OPTION		Exting. Module 1	Exting. Module 2
PRE-REL.DELAY TIME =			
EXTING. RELEASE TIME =			
DELAY ON MANUAL RELEASE ?			
EXTING. O/P 1 LEVEL =			
EXTING. O/P 2 LEVEL =			



Fire Alarm and System Warning Signs & Local Control Stations

Installation and Operations Manual Serial Communications Type

Contents

1.	Introduction.....	3
1.1.	Sign Locations.....	3
1.2.	Local Control Stations (LCS).....	3
1.3.	External Devices.....	3
1.4.	Cable Penetrations and Terminations.....	3
2.	Power and Data Connections.....	4
2.1.	Connecting Signs with RS485 Serial.....	4
2.1.1.	Connecting up to 3 Signs.....	4
2.1.2.	Connecting more than 3 Signs.....	5
3.	Connection of Local Control Station (LCS).....	6
3.1.	Power and Data Connection.....	6
3.2.	Connection to Hold and Mode inputs.....	7
3.3.	Mode input.....	7
3.4.	Hold input.....	7
3.5.	Mode select keyswitch.....	7
3.6.	Manual release.....	7
3.7.	Processor and Watchdog Reset Switches.....	8
3.8.	Internal fault indications.....	8
3.8.1.	COM.....	8
3.8.2.	LOCK OFF.....	8
3.8.3.	MOD.....	8
3.8.4.	FUSE.....	8
4.	Setting up the Devices.....	9
4.1.	Addressing Devices.....	9
4.2.	Assigning Sign Function.....	9
5.	Adding Devices to FIP Programming.....	10
5.1.	Adding / Removing Devices at the FIP.....	10
6.	Alternative Sign Arrangements.....	11
6.1.	Mimic Signs / Connecting more than 7 Signs.....	11
6.2.	Alternative Arrangement of STATUS SERIAL (RS485) Circuit.....	12
7.	Troubleshooting.....	13
8.	Specifications.....	13

1. Introduction

SIGNS - The illuminated warning signs provide a clear, visual and audible warning for a fire alarm, extinguishant release, and System inoperative. Signs have two levels of operation in which the top and bottom halves of the sign may be split to show an initial warning and then additional text for a reinforced warning, or both halves can be activated at once.

LOCAL CONTROL STATION (LCS) may be required by standards for an installation. These units can be installed using the serial bus and can be inserted anywhere in the 485 circuit.

A maximum of 7 devices (signs/LCS) can be installed when utilising the 485 Circuit.

1.1. Sign Locations

Locations where signs must be installed are defined by AS 1670. This manual does not replace reading the full standard. Signs should be firmly mounted in appropriate locations. Interior signs are rated IP30 and are designed for indoor use only. Weather Proof Signs are available. Signs are considered by the Sigma XT FIP to be OUTPUT UNIT(S)

"FIRE ALARM/DO NOT ENTER" SIGNS - Installed outside the risk area, adjacent to all egress points and clearly visible to anyone who may enter the risk area.

"FIRE ALARM/EVACUATE AREA" SIGNS - Installed inside the risk area, adjacent to all egress points and clearly visible to all occupants of the risk area.

"EXTINGUISHING SYSTEM INOPERATIVE" SIGNS - Installed adjacent to the FIP and egress points, with additional signs where necessary to be clearly visible to anyone who enters the risk area.

1.2. Local Control Stations (LCS)

LCS should be mounted firmly in an accessible location. The LCS is considered by the Sigma XT FIP to be a STATUS UNIT(S). Status units have monitored inputs to which remote Hold or Mode select switches can be connected. These inputs are monitored for open and short circuit faults and therefore need to have a 470R 1W trigger resistor connected in series with the activating, normally open switches and 6K8 0.5W end of line monitoring resistors connected across the end of the cables.

Status Units are environmental class A and are designed for indoor use only at temperatures between -5°C (± 3) and $+40^{\circ}\text{C}$ (± 2) and with a maximum relative humidity of 95%. The IP rating for the enclosure is IP30. Operation outside of these limits may render the equipment unsafe.

The 6K8 end-of-line monitoring resistors are supplied fitted to the Hold and Mode input terminals

1.3. External Devices

In addition to standard installation rules, there are some additional precautions that must be observed when installing external signs.

SUNLIGHT - If an external sign is mounted in direct sunlight, it may be difficult to see if the sign is illuminated. In this case it may be necessary to install a sun shield to make the illuminated sign visible.

DRIP LOOP - All external devices should be installed with cable penetrations coming through the bottom of the sign, with a drip loop included to avoid the accumulation and ingress of water that may damage the electronics.

1.4. Cable Penetrations and Terminations

All cable penetrations into the sign enclosures must be protected by cable glands or bushings. Each sign enclosure features a series of 20mm knockouts to accommodate these cable glands. The max size of cable that the terminals will accommodate is 2.5mm.

When preparing cable terminations, ensure that cables are not going to cross the front surface of the circuit board as this will impair the light output of the unit, and the shadows generated by the cables will be clearly visible when the sign is lit.

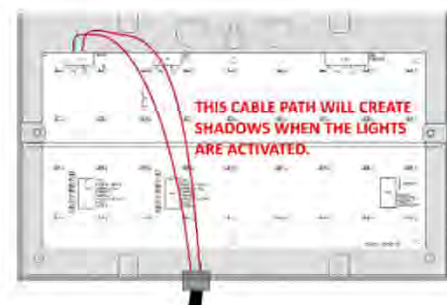

2. Power and Data Connections

Each status unit requires two cores for power and two cores for data transmission to and from the control panel. A four core cable may be used for these connections. All of these connections are polarity conscious and care should be taken to match the polarity with the corresponding terminals at the control panel.

2.1. Connecting Signs with RS485 Serial

2.1.1. Connecting up to 3 Signs

For systems requiring up to 3 signs (or devices) to be installed, wiring is as follows:

- Notes:
- FIP MUST BE POWERED DOWN BEFORE ANY CHANGES TO SIGNS.
 - STATUS POWER - will support a maximum of 3 devices, including both signs and LCS.
 - For more than 3 signs, a separate power supply is required from the 24VDC output on the FIP.
 - STATUS SERIAL (RS485) - Maximum number of devices, including both Signs and LCS, for the 485 communications is 7.

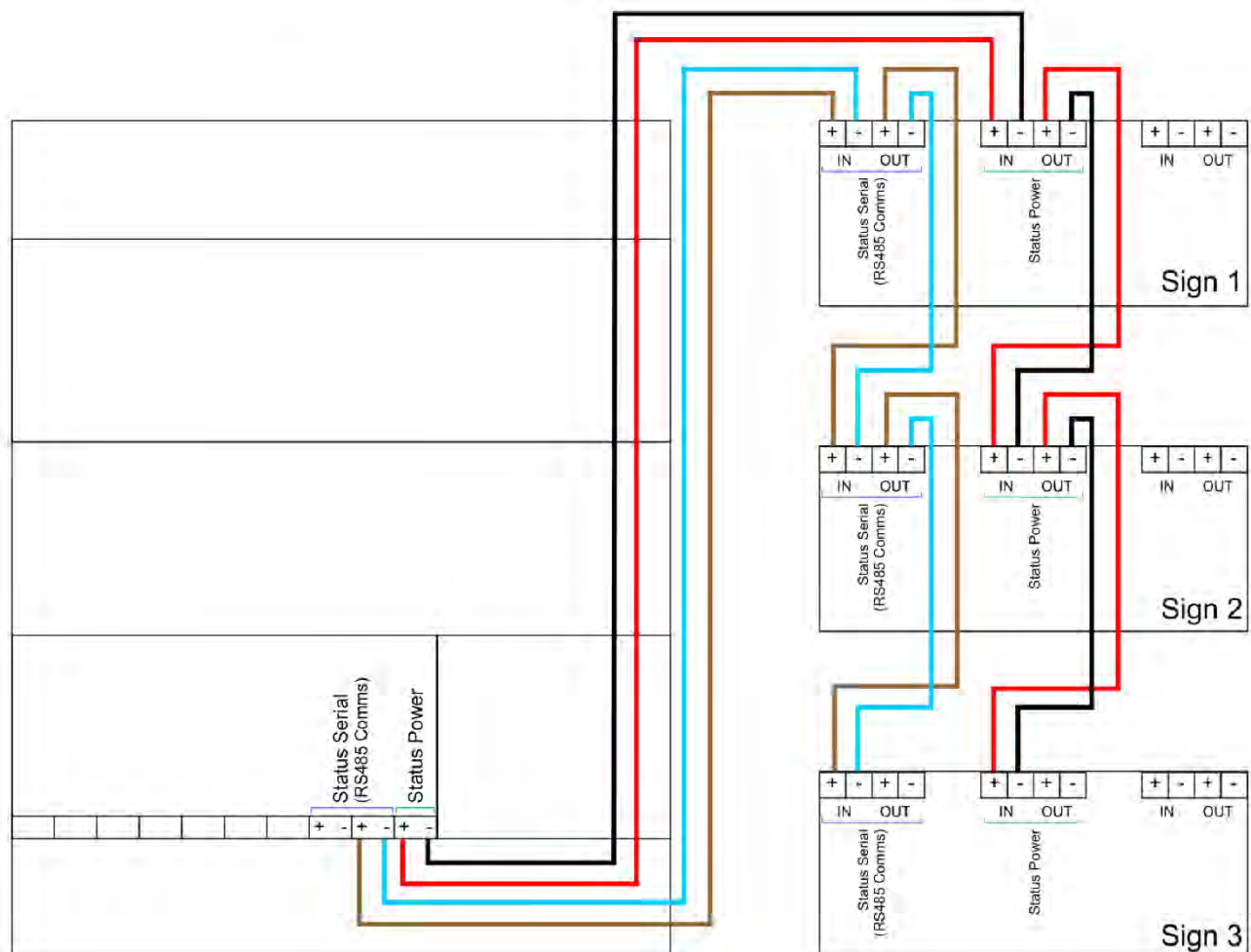

2.1.2. Connecting more than 3 Signs

For systems requiring more than 3 signs (or devices), wiring is as follows:

- Notes:
- FIP MUST BE POWERED DOWN BEFORE ANY CHANGES TO SIGNS.
 - Connections for the first 3 signs or devices remains the same as the previous wiring diagram.
 - For more than 3 signs, a separate power supply is required from the 24VDC output on the FIP.
 - STATUS SERIAL (RS485) - Maximum number of devices, including both Signs and LCS, for the 485 communications is 7. RS485 connection remains the same for all 7 devices.

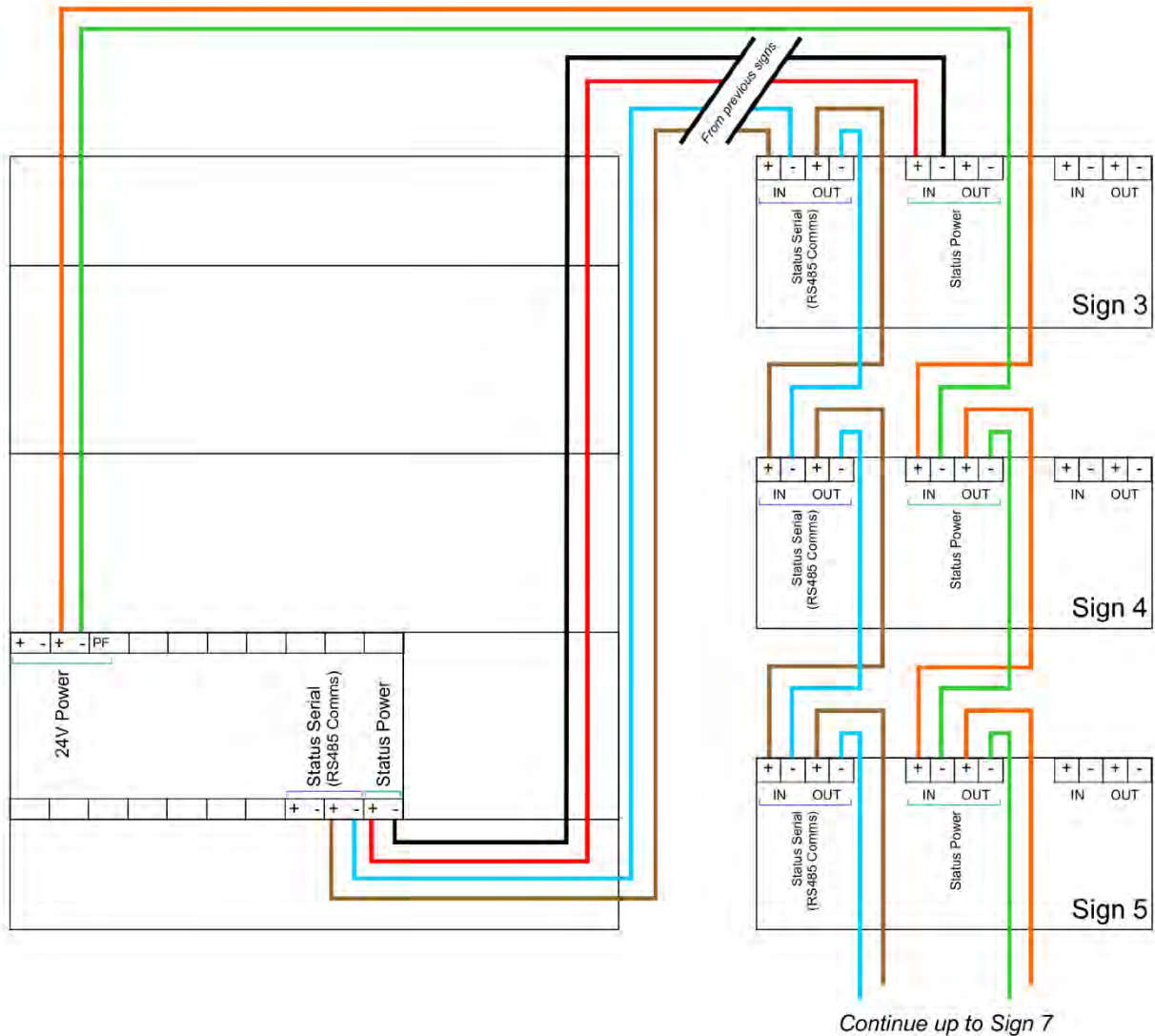

3. Connection of Local Control Station (LCS)

3.1. Power and Data Connection

The LCS can be installed in any order on the STATUS SERIAL (RS485) circuit, depending on its location. The LCS must be installed on the STATUS SERIAL (RS485) circuit. It cannot be used as a mimic device. More information is available on the Local Control Station Manual.

For systems requiring a LCS to be installed, wiring is as follows:

- Notes:
- FIP MUST BE POWERED DOWN BEFORE ANY CHANGES TO SIGNS.
 - If installed as one of the first 3 devices on the STATUS SERIAL (RS485) circuit, STATUS POWER may be used for the power supply. STATUS POWER will support a maximum of 3 devices, including both signs and LCS.
 - If installed after the first 3 devices on the STATUS SERIAL (RS485) circuit, a separate power supply is required from the 24VDC output on the FIP.
 - STATUS SERIAL (RS485) - Maximum number of devices, including both Signs and LCS, for the 485 communications is 7.

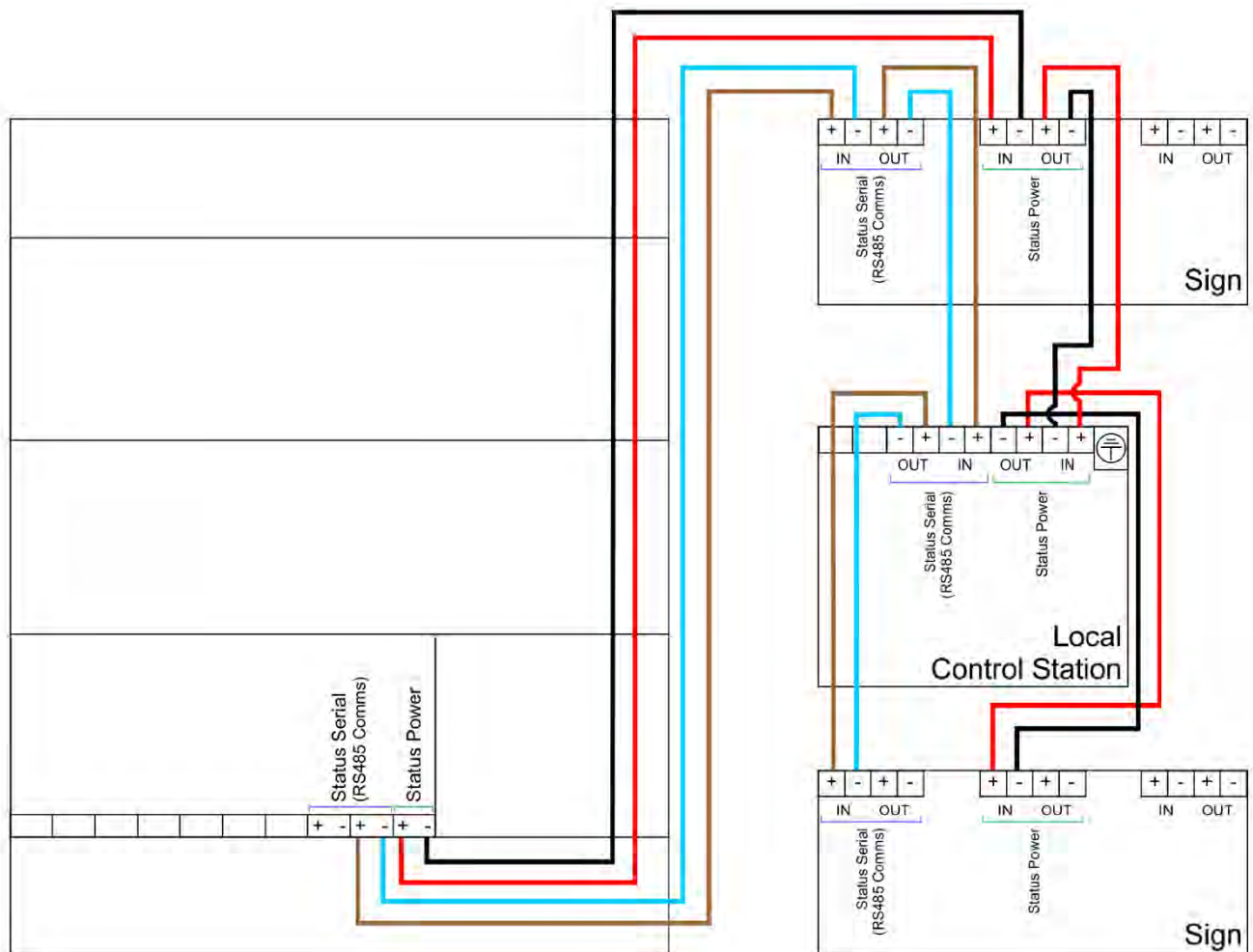

4. Setting up the Devices

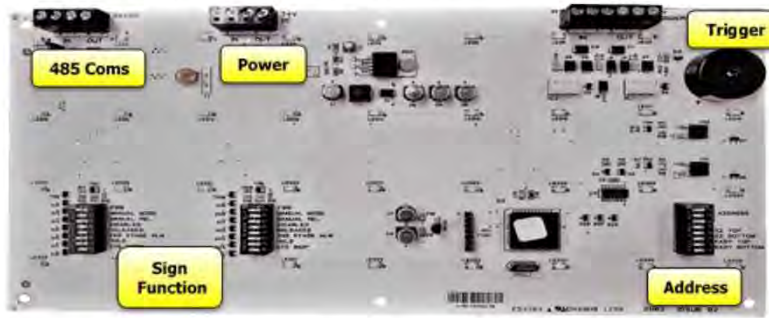

Sign Circuit Board



LCS Circuit Board

4.1. Addressing Devices

Before adding a device to the FIP's programming, each device connected to the STATUS SERIAL (RS485) circuit must be given an individual address. The FIP MUST BE POWERED DOWN BEFORE ANY CHANGES TO DEVICES.

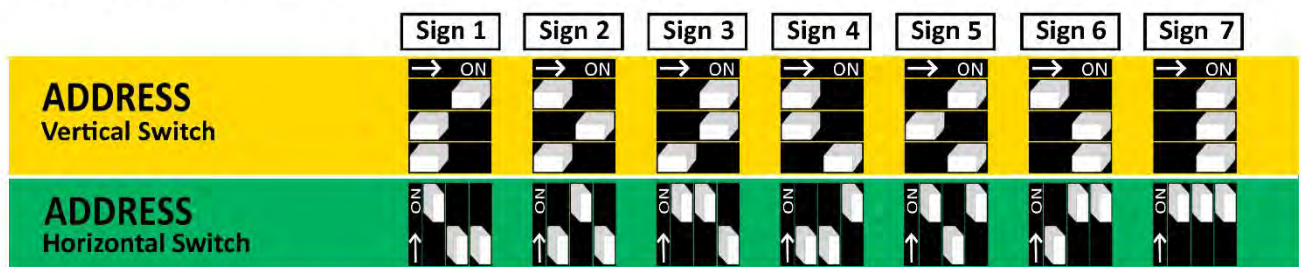

IMPORTANT - Devices with the same address will cause an intermittent fault to be displayed.

4.2. Assigning Sign Function

In addition to addressing, signs connected to the STATUS SERIAL (RS485) circuit require their function to be set using the DIL switches on the bottom of the sign circuit board. The functions of the upper and lower halves of the sign are split across 3 banks of DIL switches. The recommended sign functions for each type of sign are:

<div style="background-color: red; color: white; padding: 10px; text-align: center; font-weight: bold;"> FIRE ALARM DO NOT ENTER </div>	<div style="display: flex; align-items: center;"> <div style="margin-right: 5px;">→ ON</div> <div style="border: 1px solid black; width: 20px; height: 20px; background: white; position: relative;"> <div style="position: absolute; top: 50%; left: 50%; transform: translate(-50%, -50%);">ON</div> </div> </div>	<div style="display: flex; align-items: center;"> <div style="margin-right: 5px;">→ ON</div> <div style="border: 1px solid black; width: 20px; height: 20px; background: white; position: relative;"> <div style="position: absolute; top: 50%; left: 50%; transform: translate(-50%, -50%);">ON</div> </div> </div>	<div style="display: flex; align-items: center;"> <div style="margin-right: 5px;">→ ON</div> <div style="border: 1px solid black; width: 20px; height: 20px; background: white; position: relative;"> <div style="position: absolute; top: 50%; left: 50%; transform: translate(-50%, -50%);">ON</div> </div> </div>	<div style="display: flex; align-items: center;"> <div style="margin-right: 5px;">1 2 3</div> <div style="border-left: 1px solid black; border-right: 1px solid black; padding: 0 5px;">ADDRESS</div> </div>
	Fire Manual Mode Manual Release Disable Released 2nd Stage Alarm Hold Sys Inop	Fire Manual Mode Manual Release Disable Released 2nd Stage Alarm Hold Sys Inop	Not Used BUZZ TOP BUZZ BOTTOM STEADY TOP STEADY BOTTOM	
<div style="background-color: red; color: white; padding: 10px; text-align: center; font-weight: bold;"> FIRE ALARM EVACUATE AREA </div>	<div style="display: flex; align-items: center;"> <div style="margin-right: 5px;">→ ON</div> <div style="border: 1px solid black; width: 20px; height: 20px; background: white; position: relative;"> <div style="position: absolute; top: 50%; left: 50%; transform: translate(-50%, -50%);">ON</div> </div> </div>	<div style="display: flex; align-items: center;"> <div style="margin-right: 5px;">→ ON</div> <div style="border: 1px solid black; width: 20px; height: 20px; background: white; position: relative;"> <div style="position: absolute; top: 50%; left: 50%; transform: translate(-50%, -50%);">ON</div> </div> </div>	<div style="display: flex; align-items: center;"> <div style="margin-right: 5px;">→ ON</div> <div style="border: 1px solid black; width: 20px; height: 20px; background: white; position: relative;"> <div style="position: absolute; top: 50%; left: 50%; transform: translate(-50%, -50%);">ON</div> </div> </div>	<div style="display: flex; align-items: center;"> <div style="margin-right: 5px;">1 2 3</div> <div style="border-left: 1px solid black; border-right: 1px solid black; padding: 0 5px;">ADDRESS</div> </div>
	Fire Manual Mode Manual Release Disable Released 2nd Stage Alarm Hold Sys Inop	Fire Manual Mode Manual Release Disable Released 2nd Stage Alarm Hold Sys Inop	Not Used BUZZ TOP BUZZ BOTTOM STEADY TOP STEADY BOTTOM	
<div style="background-color: yellow; padding: 10px; text-align: center; font-weight: bold;"> SYSTEM INOPERATIVE </div>	<div style="display: flex; align-items: center;"> <div style="margin-right: 5px;">→ ON</div> <div style="border: 1px solid black; width: 20px; height: 20px; background: white; position: relative;"> <div style="position: absolute; top: 50%; left: 50%; transform: translate(-50%, -50%);">ON</div> </div> </div>	<div style="display: flex; align-items: center;"> <div style="margin-right: 5px;">→ ON</div> <div style="border: 1px solid black; width: 20px; height: 20px; background: white; position: relative;"> <div style="position: absolute; top: 50%; left: 50%; transform: translate(-50%, -50%);">ON</div> </div> </div>	<div style="display: flex; align-items: center;"> <div style="margin-right: 5px;">→ ON</div> <div style="border: 1px solid black; width: 20px; height: 20px; background: white; position: relative;"> <div style="position: absolute; top: 50%; left: 50%; transform: translate(-50%, -50%);">ON</div> </div> </div>	<div style="display: flex; align-items: center;"> <div style="margin-right: 5px;">1 2 3</div> <div style="border-left: 1px solid black; border-right: 1px solid black; padding: 0 5px;">ADDRESS</div> </div>
	Fire Manual Mode Manual Release Disable Released 2nd Stage Alarm Hold Sys Inop	Fire Manual Mode Manual Release Disable Released 2nd Stage Alarm Hold Sys Inop	Not Used BUZZ TOP BUZZ BOTTOM STEADY TOP STEADY BOTTOM	

5. Adding Devices to FIP Programming

In order to add or remove devices from the FIP programming, the FIP must be in "ACCESS LEVEL 3".

The steps to enter "ACCESS LEVEL 3" are as follows:

1. Unlock and open the centre display window. This operates a read switch on the door that enables "ACCESS LEVEL 2". The centre lock opens the display window, allowing for operation of the controls.



2. Unlock and open the main door for the FIP. The top and bottom locks will open the complete cabinet front allowing for full access to the FIP controls. Ensure that the display window is kept open.
3. Move the Write/Enable switch on the lower extinguishant module to the left "Write" position. This enable "ACCESS LEVEL 3" and allows for programming of the signs.



Normal – The Slide Switch is to the Right

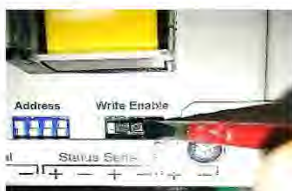

To Access Level 3 – move the Slide Switch to the Left



Access Level 3 – The Slide Switch is to the Left

A "CONFIG WP" Fault will show if the Slide Switch is not returned "ENABLE".

5.1. Adding / Removing Devices at the FIP

FIP SHOULD BE POWERED DOWN before any changes are made to status units. When the system is first powered on, it will search for connected status units connected to extinguishant module. If status units are connected correctly and detected by the control FIP, the LCD will display:

X FAULTS
Enter TO VIEW

Open the *Display Window* and Press *Enter* on the module to which the status units are connected. Use the "+" button on the module to view the faults. If status units are detected the LCD will display, X = the address of the status unit found.

STATUS UNIT X
FAULT

To accept the status units found, **slide the WRITE ENABLE switch**, on the module to which the status units or ancillary boards are connected to write mode. The LCD will then display, X= the address of the status unit found.

STATUS UNIT X
Enter TO ACCEPT

Then press the *Enter* button, the selected status unit or ancillary board will be added to the system and the next unit to be added will be displayed. Press the *Enter* button on the extinguishant module until all the units have been accepted then slide the *Write Enable* switch to enable mode.

All of the status units found module have now been added and disconnection of any of them will be displayed as a fault on the module and on the detection part of the system. If any status units are disconnected, a Lock Off activated indication will also be displayed at the extinguishant module and all ancillary boards or status units that remain connected. With the *Display Window* Closed, the LCD will display:

REMOTE BUS
FAULT

The Status units which are disconnected will have all their indicators flashing. When additional status units are added, these will be shown on the LCD when the system is powered up.

6. Alternative Sign Arrangements

6.1. Mimic Signs / Connecting more than 7 Signs

In systems that require more than 7 signs, additional signs may be installed by connecting to the 24VDC TRIGGER terminals located in each sign. This allows connected signs to mimic the operation of a sign that is connected to the STATUS SERIAL (RS485) circuit. Note: signs can only mimic other signs of the same type (A "Do Not Enter" Sign can only mimic another "Do Not Enter" Sign).

The 24VDC trigger function of each sign connected to the STATUS SERIAL (RS485) circuit can support up to 3 additional signs.

There is no need to configure the address or sign function switches, however the internal buzzer and flashing functions can still be adjusted separately.

IMPORTANT – An additional external power supply OR an upgraded power supply in the FIP is required for any additional devices over the standard maximum of 7 devices. Each sign has a current draw of 140mA. When installing, power supply (including backup supply) must be assessed to ensure that it will be adequate.

While it is possible to use this configuration with fewer than 7 devices, it is not recommended.

The LCS must be installed on the STATUS SERIAL (RS485) circuit. It cannot be used as a mimic device.

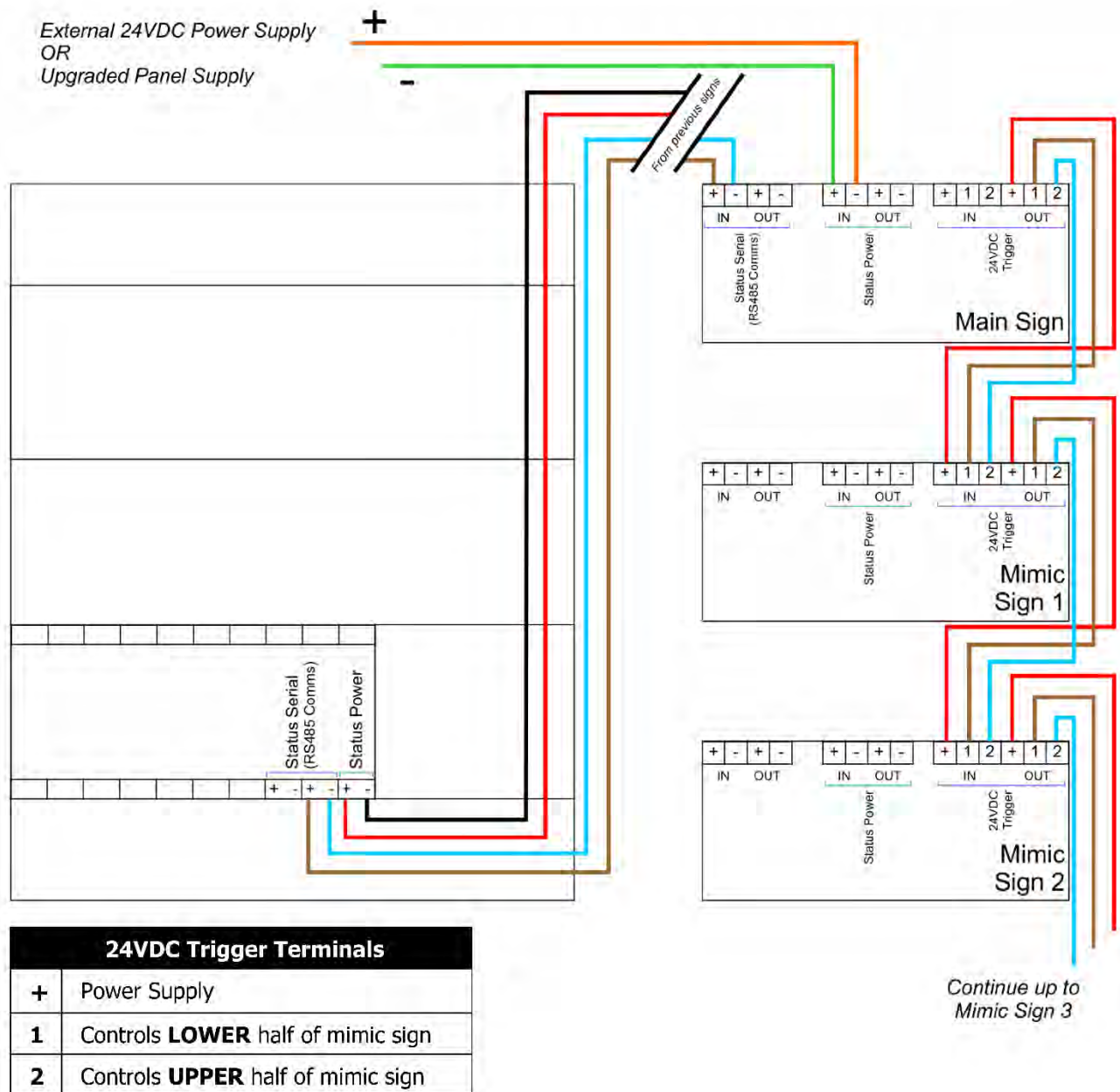

6.2. Alternative Arrangement of STATUS SERIAL (RS485) Circuit.

The standard arrangement for installing signs is to have a single STATUS SERIAL (RS485) cable connecting the FIP to the signs, as per wiring diagram. However, it can be configured to have 2 separate cables for the RS485 circuit with the FIP effectively in the middle of the circuit rather than at one end.

FIP MUST BE POWERED DOWN BEFORE ANY CHANGES TO SIGNS. If process is done with power connected there is a possibility that a short could occur and damage the FIP.

IMPORTANT - When this configuration is used the LK2 link on the extinguishant module MUST be removed or positioned over 1 pin only, or the FIP will register a fault.

An example of this type of wiring arrangement is as follows:

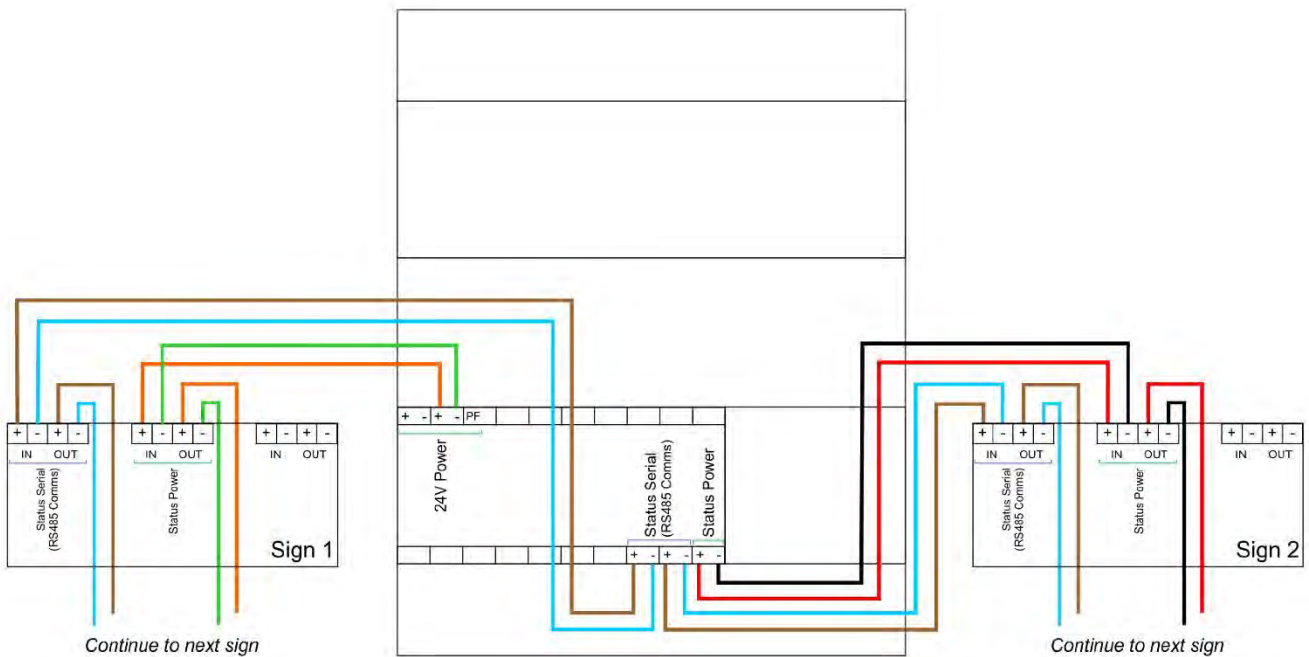

7. Troubleshooting

OUTPUT UNIT X FAULT →

Output Unit refers to a SIGN, this fault will be

- Address is the same as another device in the 485 circuit
- Power has failed to the sign.
- RS485 signal has failed to the sign.

STATUS UNIT X FAULT →

Status Unit refers to an LCS, this fault will be

- Address is the same as another device in the 485 circuit
- Power has failed to the LCS.
- RS485 signal has failed to the LCS.

8. Specifications

	Internal Sign	External Sign	Local Control Station
Size	195 x 300 x 50mm	195 x 300 x 50mm	135 x 186 x 50mm
Material	1.2mm steel Epoxy coat	Thermoplastic	1.2mm steel Epoxy coat
IP Rating	IP 40	IP 55	IP 40
Op. Voltage	15V to 30V DC	15V to 30V DC	21 to 30v DC
Current – Quiesant	20 mA	20 mA	60 mA
Current – Alarm State	140 mA	140 mA	70 mA



**Sigma-XT-ECU-LCS
Extinguishant Control Unit
Local Control Station**

Operation and Maintenance Manual

Sigma-XT-ECU-LCS Issue 1 October 2011



Index

Section	Page
1 Introduction	3
2 Safety and mounting	3
2.1 Safety	3
2.2 Static precautions	3
2.3 Mounting	4
3 Technical specification	5
4 Status Unit fascia	5
5 Connecting to the circuit board	6
6 Power and data connections	7
7 Connection to Hold and Mode inputs	8
8 Mode input	8
9 Hold input	8
10 Mode select keyswitch	9
11 Manual release	9
12 Addressing status units	9
13 Processor and watchdog reset switches	9
14 Internal fault indications	10
14.1 COM	10
14.2 LOCK OFF	10
14.3 MOD	10
14.4 FUSE	10
15 Adding new status units/ancillary boards	11
16 Removing status units	11

1 Introduction

The Sigma-SI Status Units are designed in accordance with Australian Standard AS ISO 14520.1-2009 Gaseous fire-extinguishing systems - Physical properties and system design - General requirements (ISO 14520-1:2006, MOD)

The Status Units are designed to extend the indications and some controls of Sigma XT extinguishant control panels to other locations within the fire protection system to make operation of the system more practical within areas that have multiple access points (or doors). A maximum of seven status units may be connected to each control panel extinguishant area.

All units connect to a two wire data communications bus and are powered by the Auxiliary 24V DC output of compatible, extinguishant control panels.

In addition to the requirements of AS ISO 14520.1 status units have the following facilities:

Signal representing the flow of extinguishing agent to indicate the released condition.

Monitoring of the status of components by way of a low pressure switch input.

Emergency hold device to enable the extinguishant delay time to be extended.

Manual only mode to disable the release of extinguishant via automatic detection devices. .

2 Safety and mounting

2.1 Safety

Suppliers of articles for use at work are required to ensure as reasonably as is practical that the article will be safe and without risk to health when properly used.

An article is not regarded as properly used if it is used 'without regard to any relevant information or advice' relating to its use made available by the supplier.

This product should be installed, commissioned and maintained by trained service personnel in accordance with the following:

- (i) Local regulations for electrical equipment in buildings
- (ii) Codes of practice
- (iii) Statutory requirements
- (iv) Any instructions specifically advised by the manufacturer

You are therefore requested to take such steps as are necessary to ensure that you make any appropriate information about this product available to anyone concerned with its use.

This equipment is designed to be operated from 24V DC supplies.

Status Units are environmental class A and are designed for indoor use only at temperatures between -5°C (± 3) and $+40^{\circ}\text{C}$ (± 2) and with a maximum relative humidity of 95%.

The IP rating for the enclosure is IP30.

Operation outside of these limits may render the equipment unsafe.

2.2 Static precautions

Installation of the panel should be carried out by qualified personnel only. The electronic components within the panel are vulnerable to physical damage and damage by electrostatic discharges.

It is advisable to wear a wrist strap designed to prevent the build-up of static charges within the body, before handling any electronic circuit boards.

Never insert or remove boards or components with the power on.

2.3 Mounting

Surface mounting Status Units should be mounted on a dry, flat surface, at eye height to the seven segment display and in a level position such that the enclosure is not distorted.

Screws or bolts of a minimum of 4mm diameter must be used to mount the enclosure in all four mounting positions.

Suitable fixings should be used at all fixing points such that the unit is securely mounted and is not liable to move once fixed.

Status Units should not be mounted near sources of excessive heat.

Units can be flushed into a wall by fitting a flushing collar (part number M8FC) between the box and lid. This can be used on any standard Sigma Si status unit, but not the weatherproof version.

Cables should be connected using suitable cable glands. If additional cable entry points are required, all swarf and debris caused by drilling of additional cable entries must be cleared before power is applied to the Status unit.

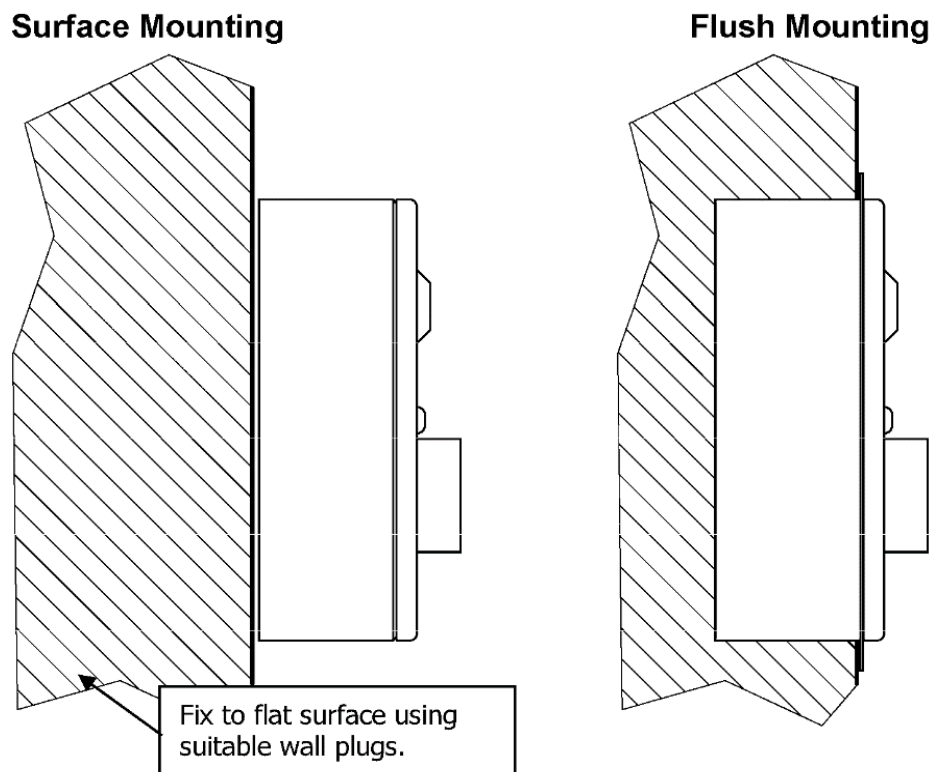

Figure 1. Mounting

3 Technical specification

Table 1 - Electrical specifications

Power supply	21 to 30 V DC	
Maximum current draw	0.07A	
Maximum number of status units	7	
Quiescent current	0.06A	
Terminal capacity	0.5mm ² to 2.5mm ² solid or stranded wire	
Monitored inputs end of line resistor	6K8 0.5W Resistor	<i>Supplied in terminals</i>
Monitored inputs normal threshold	8K ohm to 1K ohm	
Monitored inputs trigger threshold	700 ohms to 100 ohms	
Monitored inputs Short circuit threshold	99 ohms to 0 ohms	
Data connection	Two wire RS485 connection (max 1200 metres)	<i>Maximum of 7 units- RS485 data cable</i>

4 Status Unit fascia

Status units have LED indicators and controls as shown below.

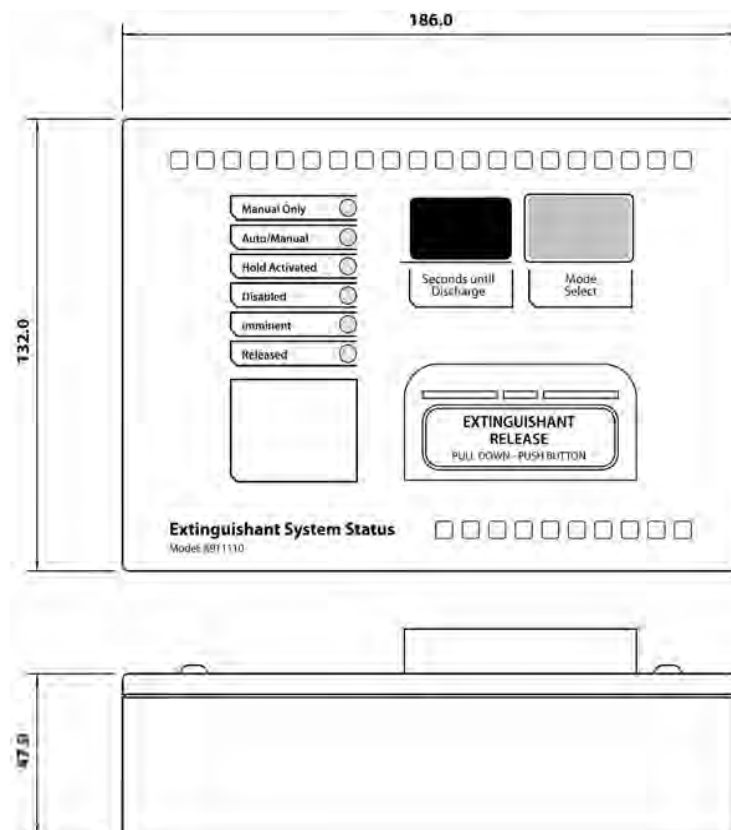

Available in surface and flush mount.

5 Connecting to the circuit board

All connections for field wiring are to a single row of terminals along the side of the circuit board. Cabling must comply with the relevant Australian Standards. The resistance of any core of any cable must not exceed 25 ohms. Wiring should enter the enclosure at the top, bottom or back of the unit using the knockouts provided and be formed tidily to the appropriate terminals. Terminals are capable of accepting wires of up to 2.5mm².

Wiring must not go across the front of the circuit board. If cable entries need to be in positions other than at the knockouts provided, wiring must be fed well away from the surface of the circuit board.

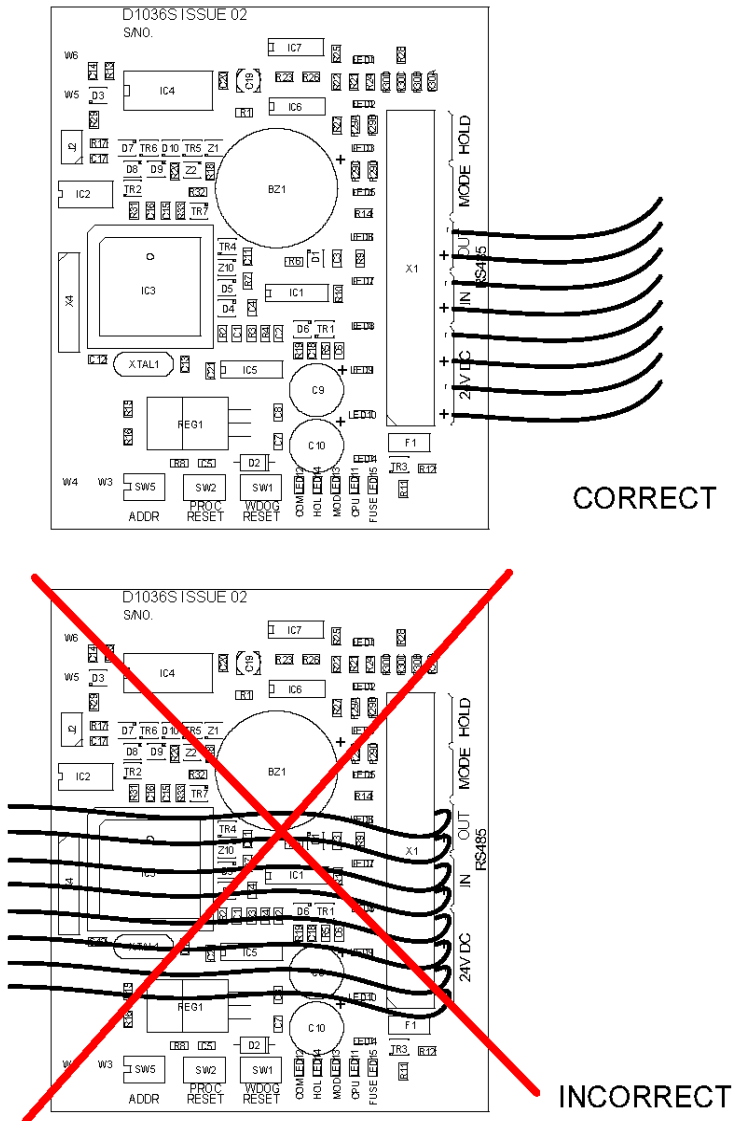
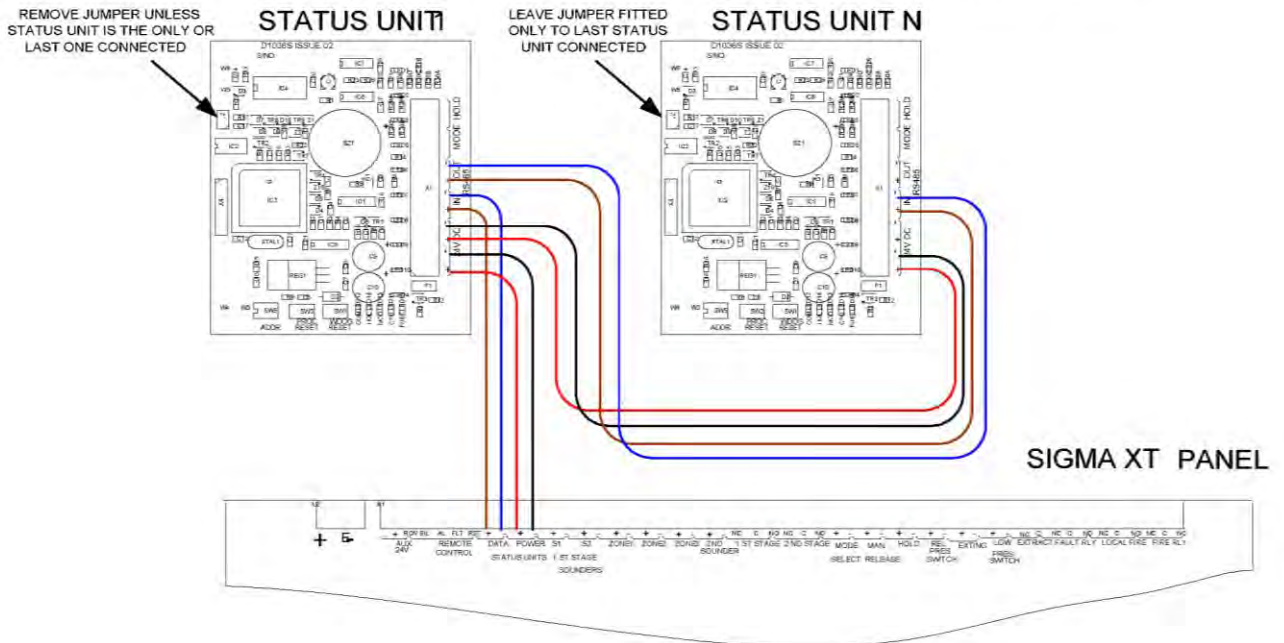

Figure 5 Wiring to the circuit board

6 Power and data connections

Each status unit requires two cores for power and two cores for data transmission to and from the control panel. A four core cable may be used for these connections. All of these connections are polarity conscious and care should be taken to match the polarity with the corresponding terminals at the control panel.



Data Termination

Up to seven status units can be connected to an extinguishant control panel. In and out terminals for data and 24V DC are provided on each unit.

All status units are supplied with a push on jumper fitted at position J2 on the left hand side of the PCB. This jumper connects a terminating resistor which needs to be in place at the last status unit on the data line. If more than one status unit is to be fitted then the jumpers must be removed from all status units except the last one.

If there is only one status unit fitted then the jumper should be left in place.

7 Connection to Hold and Mode inputs

Status units have monitored inputs to which remote Hold or Mode select switches can be connected. These inputs are monitored for open and short circuit faults and therefore need to have a 470R 1W trigger resistor connected in series with the activating, normally open switches and 6K8 0.5W end of line monitoring resistors connected across the end of the cables.

The 6K8 end-of-line monitoring resistors are supplied fitted to the Hold and Mode input terminals and the 470R trigger resistors are supplied in the accessory bag with the status unit. If either of these inputs are not being used then the end of line monitoring resistors should be left in the Hold and/or Mode terminals.

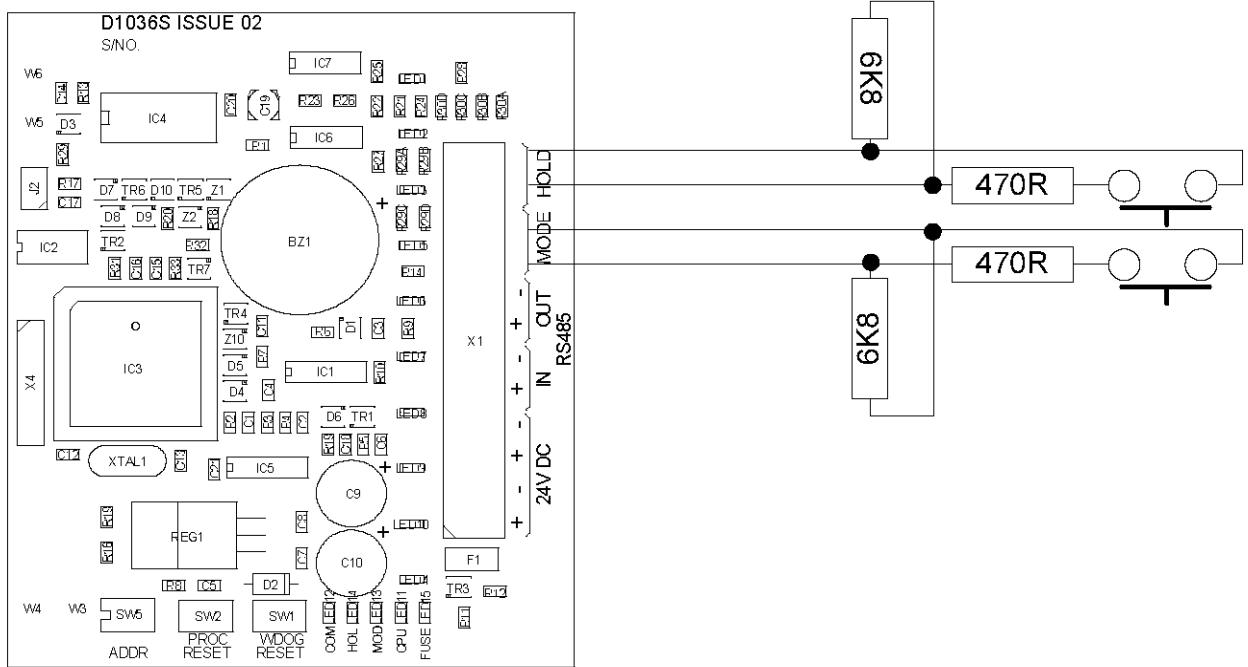

8 Mode input

The mode input is provided to allow connection of remote mode switch or to connect to door interlock contacts. The system is designed such that any Manual only mode input on the system that is active (input operated by 470R trigger resistor) will put the system into Manual only mode regardless of the status of any other Mode inputs. Therefore, for the system to be in Automatic and manual mode, all Mode inputs must be inactive.

Indication of the Mode is given on the front of the status unit by the Manual only or Automatic and manual LEDs.

9 Hold input

When active (input operated by a 470R trigger resistor) the Hold input allows the extinguishant release countdown timer to be reset to its maximum time. When the input is de-activated the countdown to extinguishant release will re-start at the maximum time that is configured at the panel (0 to 60 seconds).

IMPORTANT NOTE: When there is a fault on the HOLD input then the HOLD function is invoked which means that the extinguishant release will not operate until this condition is cleared.

10 Mode select keyswitch

Some models of the status units have a mode select switch. The operation of the Mode select switch is as per the Mode input above.

11 Manual release

Some models of the status units are fitted with a manual release button. This replicates the action of the manual release control at the main control panel and once activated will start the extinguishant release sequence.

A plastic seal is provided in the accessory pack and should be fitted to the manual release flap with a piece of thin wire to provide an indication if the manual release has been tampered with.

12 Addressing status units

To enable the control panel to know whether any status units that should be connected have been disconnected and indicate a fault condition, each status unit must be allocated and address. The address switch should never be set with all switches off.

This is done by setting a binary number from 1 to 7 on the 3 way, DIL switch located at the bottom of the status unit PCB.

The order of the addresses is not important but each status unit must be allocated a different address.

The switch settings for each of the addresses are shown below.



13 Processor and watchdog reset switches

The status unit is controlled by a microprocessor, which will re-start itself and continue to run if it stops for any reason such as severe electrical interference such as an electrical storm.

To ensure that the unit is not being subjected to continual, undue interference which may effect its proper operation, a CPU fault indicator is latched on and a fault condition signalled to the control panel.

If a processor re-start has occurred this latched fault condition will need to be reset by pressing the WDOG RESET button on the bottom of the PCB.

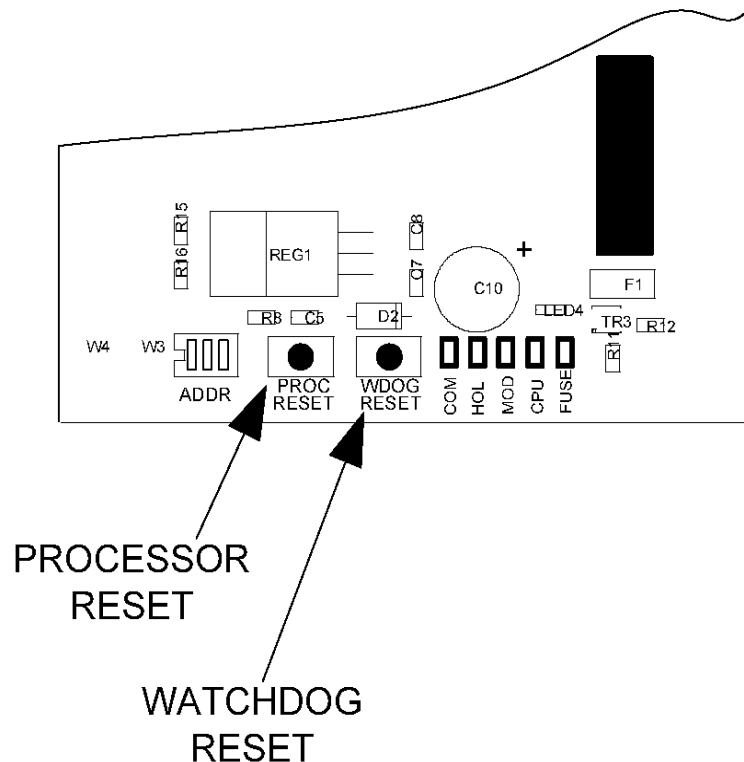

A switch is also provided to manually re-start the processor PROC RESET. This switch can be used while the status units are connected to the system to ensure that the unit starts up and establishes communication with the panel in a controlled and expected manner.

14 Internal fault indications

An extinguishant fault indication at the control panel may mean that there are faults at one or more status units. The status unit fault indications are located along the bottom of the PCB and are as follows:

14.1 COM

This LED indicates that the data communications connection to the control panel is not present. This may be because the data lines are connected with reverse polarity or are not connected. Check RS485 IN and OUT connections.

14.2 LOCK OFF

This LED indicates that the Lock Off input is open or short circuit. Check that the correct end of line resistor is connected to the Lock Off terminals or at the end of the wires connected to the Lock Off terminals and that the Lock Off input is not short circuited, or the wiring open circuited.

IMPORTANT NOTE: When there is a fault on the Lock Off input then the Lock Off function is invoked which means that the extinguishant release will not operate until this condition is cleared.

14.3 MOD

This LED indicates that the MODE input is open or short circuit. Check that the correct end of line resistor is connected to the MODE terminals or at the end of the wires connected to the MODE input and that the MODE input is not short circuited.

14.4 FUSE

This LED indicates that the electronic fuse has operated. Under this condition, the status unit is not operational. This may be due to incorrect polarity of the power connection or a failure on the unit itself.

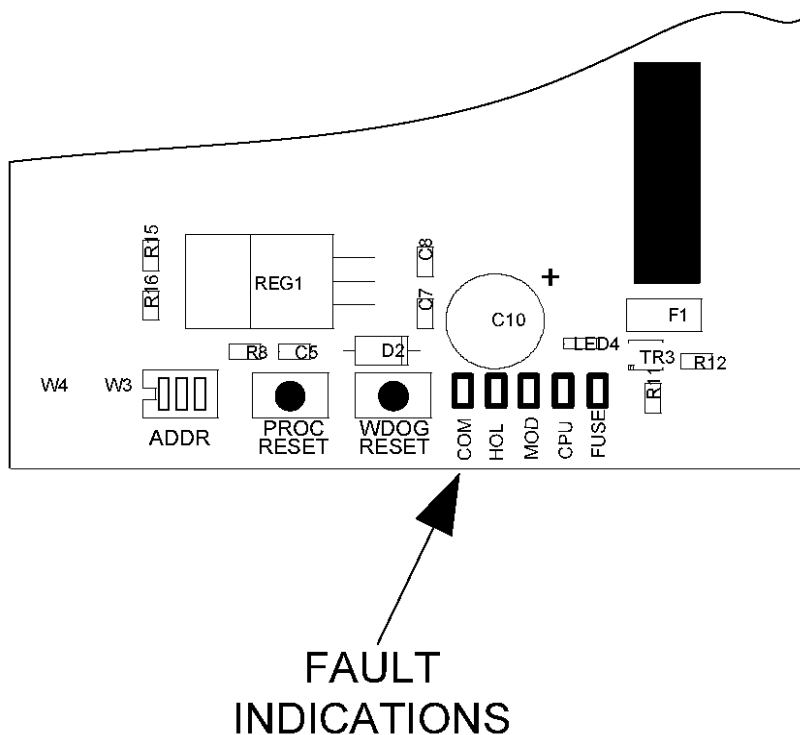

15 Adding new status units/ancillary boards

When the system is powered, it will search for connected status units.

When new or additional status units are added to the system, these will be shown on the display when the system is first powered.

Status units are shown as **Pux** (where x is the address of the unit found).

The select key can be used to view all of the status units that the system has found.

These should be checked to ensure that the same number of devices that have been fitted, are found by the system.

For the system to accept these into its memory, the procedure below must be followed.

1. Operate the Enable Controls keyswitch.
2. Enable the Write Enable Switch (push to the right) – Access level 3.
3. The display will show **Pux** for status units that are found (where x is the address of each unit) and the dot in the display will be flashing. Operate the Enter button which will accept the displayed unit and step through to the next unit found.
4. When the Enter button does not step on to any other units, all devices have been accepted.
5. Disable the Write enable switch (push to the left).
6. Disable the Enable controls keyswitch.
7. The panel should return to the normal, quiescent condition.

16 Removing status units

When status units are to be removed from the system, the system must be powered down first and the status units removed. The system should then be powered. When the system starts it will be in fault and the units removed will be shown on the display. Status units are shown as **Pux** (where x is the address of the unit). The Select button can be used to view all of the status units that the system expects to be found but are now missing.

For the system to accept the removal of these devices from its memory the following procedure must be carried out.

1. Operate the Enable Controls keyswitch.
2. Enable the Write Enable Switch (push to the right) – Access level 3.
3. Wait for the General fault LED to illuminate
4. Disable the Write enable switch (push to the left)
5. Disable the Enable controls keyswitch
6. The panel should return to the normal quiescent condition.

If the panel fails to receive messages from a status unit after it has been stored in the configuration memory, the internal "comms fault" LED will light and a fault condition will be displayed on the panel fascia. The seven segment display on the panel will show the number of the unit that is disconnected and all LEDs on the status unit that is disconnected will flash.



National Distribution



Available Nationally From:

SYDNEY - Incite Fire

Address Block Y, Unit 1 Regents Park Estate, 391 Park Road, Regents Park, NSW 2227

Phone 02 9644 7144

Facsimile 02 9644 7255

Email sales@incitefire.com.au

MELBOURNE - Incite Fire

Address Unit 120, 45 Gilby Road Mt Waverley VIC 3149

Phone 03 9544 2211

Facsimile 03 9544 2212

Email salesvic@incitefire.com.au

BRISBANE - eFire Technologies

Address 25 Jeays Street Bowen Hills QLD 4006

Phone 07 3252 5366

Facsimile 07 3252 4099

Email sales@efiretechnologies.com.au



www.incitefire.com.au



1300 INCITE

www.incitefire.com.au



Conventional Fire Control Panel Extinguishant for Aerosol Release Installation of Thermal Fuse

SIGMA-XT-Thermal Fuse

Issue 1.0

May 2018

Contents

1. Introduction.....	2
2. Mounting	2
3. Connecting to the circuit board	3
3.1. Thermal Fuse Connection.....	4
3.1.1. Released Indication	4
3.1.2. Release Pressure Switch – Normal/Invert.....	4
3.2. Low pressure switch	4
3.3. Abort input.....	4
4. Maintenance	4

1. Introduction

The FirePro SIGMA XT-A, conventional fire alarm control panel with Extinguishant Control Unit and Aerosol Agent Controller, is designed to comply with AS7240-2, AS7240-4 Fire Detection and Fire Alarm Systems - Control and Indicating Equipment, and AS ISO 14520.1 2009 Gaseous Fire Extinguishant Systems.

The thermal fuse is required by AS-4487 as an indicator that the system has activated.

2. Mounting

This thermal fuse should be mounted on the most convenient – or closet FirePro unit to the Control Panel.

Normally only one thermal fuse is required in each system. However multiple thermal fuse can be mounted where necessary, for example where a system covers multiple risk areas/rooms.

This thermal fuse is mounted in a cast alloy enclosure, and this is rated to IP65. The mounting of the unit will determine the final IP rating. It designed for use at temperatures between -5°C (+/- 3) and $+40^{\circ}\text{C}$ (+/-2) and with a maximum relative humidity of 95%.

MOUNTING – The thermal fuse is mounted directly over the thermal port of the FirePro Aerosol generator.

Cables should be connected using 2 Pin Deutsch Plugs.

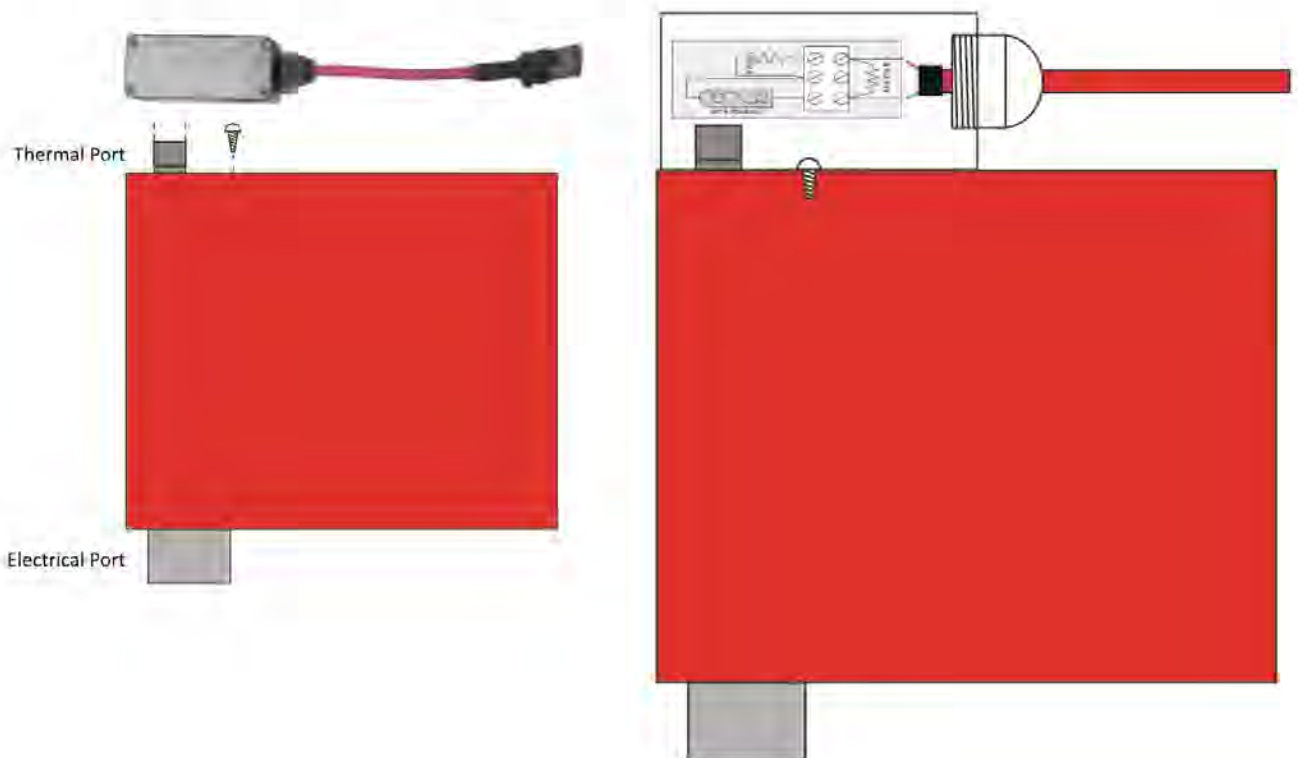

3. Connecting to the circuit board

All connections for field wiring are to a single row of terminals along the top of the circuit board.

The connections for the power cables are to a pluggable terminal block which may be pulled off of the board to remove power from the PCB assembly. Remove this pluggable terminal only with MAINS POWER OFF.

Cabling must comply with the Australian Standards. The resistance of any cable must not exceed 25 ohms.

Terminals are capable of accepting wires of up to 2.5mm².

Wiring must not go across the front of the circuit board plate or between the plate and the circuit board.

If cable entries need to be in positions other than at the knockouts provided, wiring must be fed behind and well away from the surface of the circuit board.

The space at the bottom of the enclosure is largely occupied by the batteries so this must be borne in mind when considering cable entries.

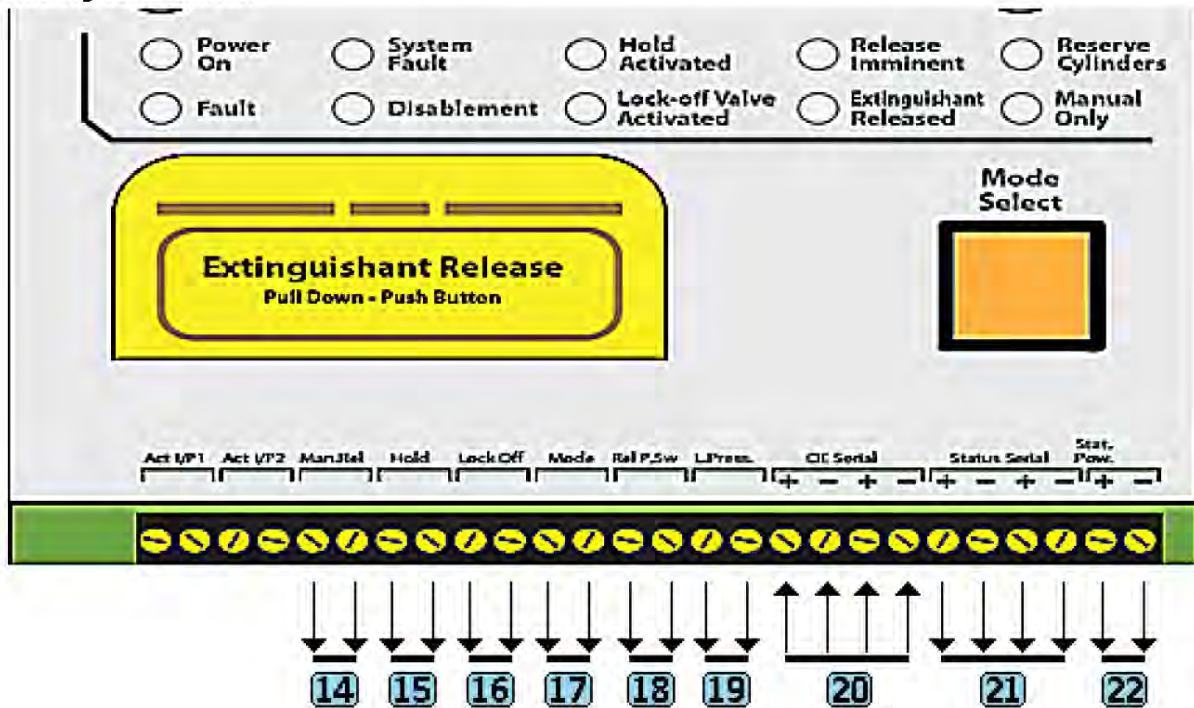

1	24vDC Input from PSU		
2	PF Input from PSU		
3	Aux 24vDC Output		
4	Fault relay Contact		
5	Stop Air Conditioning		
6	Shutdown Power		
7	Released Relay Contact		
8	Aborted Relay Contact		
9	Extract Fan Power		
10	1st Stage Sounders	EOL 10K	
11	2nd Stage Sounders	EOL 10K	
12	Releasing Solenoid		1N4004 Diode
13	Releasing Solenoid		1N4004 Diode
14	Remote Manual Release Switch		EOL 470K
15	Remote Hold Switch		EOL 470K
16	Remote Abort Switch		EOL 470K
17	Remote Auto/Manual Select Switch		EOL 470K
18	Exting Release Pressure Switch		EOL 470K
19	Exting Low Pressure Switch		EOL 470K
20	Internal Connection from Panel		
21	Serial data to Status Units		
22	Power to Status Units		

3.1. Thermal Fuse Connection

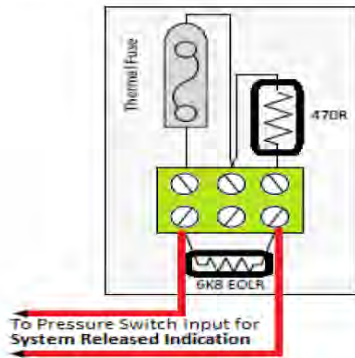

The Thermal Fuse provides notification to a control panel that a FirePro unit has activated. It should be installed in accordance with the instructions included in the relevant FirePro document.

Menu setting in the XT card allows for a **normally closed (inverted)** input to be used (10.3.16).

Connect Thermal Fuse to Rel.P Switch

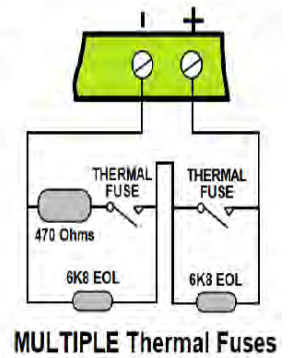

3.1.1. Released Indication

It is possible to select whether the released indication on a module is operated at the same time as the extinguishant release outputs operate or by operation of a pressure switch connected to the released, pressure switch input.

The factory default setting is for the released indication to be operated by operation of a pressure switch connected to the pressure switch input.

To change, open the *Display Window* and slide the *Write Enable* switch on the module to be configured gently to the right. Press the *Enter* button on the extinguishant module then press the "+" button until the display shows:

To change press *Enter*. To save, slide the *Write Enable* switch to the right.

**RELEASE IND ON
RELEASED INPUT**

**RELEASED IND ON
EXTING. REL ?**

3.1.2. Release Pressure Switch – Normal/Invert

To enable released pressure switches to be used which have normally closed rather than normally open contacts, it is possible to invert the released pressure switch input. The factory default setting is for the pressure switch input to use a normally open contact.

To invert, open the *Display Window* and slide the *Write Enable* switch to the left. Press the *Enter* button on the extinguishant module then press the "-" button until the display shows:

Press the *Enter* button to change to this.

The released pressure switch input needs to be disconnected to bring it into fault before changing from Normal to Inverted or back in order to prevent the input from activating.

To save, slide the *Write Enable* switch to the right. The released pressure switch input will now require a normally closed contact via a 470R trigger resistor and 6K8 end of line resistor for correct supervision.

**RELEASED INPUT
MODE = NORMAL**

**RELEASED INPUT
MODE – INVERTED ?**

3.2. Low pressure switch

This is for Pressurised systems and is NOT USED for FirePro Aerosol installations.

3.3. Abort input

Each module has the facility for connection of an Abort control. Operation of the Abort input or a fault on the monitored wiring of the Abort circuit during the pre-release delay time or before activation will light the Abort indicator on the module and the extinguishant release timer will be cancelled i.e. the extinguishant will not be released. The module can be immediately reset from this condition.

4. Maintenance

Thermal fuses do not require any specific maintenance but should be free of debris.

The circuit is monitored and should any damage to connections or the cabling will create a fault condition on the panel.

5. Equipment Data Sheets

5.1. SIGMA XT Conventional Fire Control Panel



Sigma XT Extinguishant Control Panel

Rev 1.1



Product Overview

The Sigma XT extinguishant control panel is designed to the requirements of AS7240.0 and ASISO 14520.1

Each extinguishing module has a comprehensive set of inputs and outputs and is configurable via the LCD display and simple menus.

The data bus cabling of the Sigma warning signs and Sigma local control stations, simplifies and minimises cable requirements and maximises monitoring of these devices.

Standard Features

- Fully certified to AS 7420.2 and AS7240.4
- 2-wire and standard versions in 2 or 8 zones
- Fully programmable using simple menu

Options

- Sounder configuration options
- Coincidence input selection
- Compatible with wide range of detection devices
- Two monitored sounder outputs

Technical Data

Construction	1.2mm mild sheet steel
IP Rating (Standard unit)	IP30
Colour - lid & box	BS 00 A 05 grey - fine texture
Power supply	230V AC (+10%/-15%)
Fault contact rating	30V DC 1 Amp
Local fire contact	30V DC 1 Amp
Fire contact rating	30V DC 1 Amp
Cable capacity	2.5mm ² per terminal
Operating temperature	-5°C to +40°C
Operating humidity	<95% (non condensing)
data connection	RS485 connection (max 1200 m)

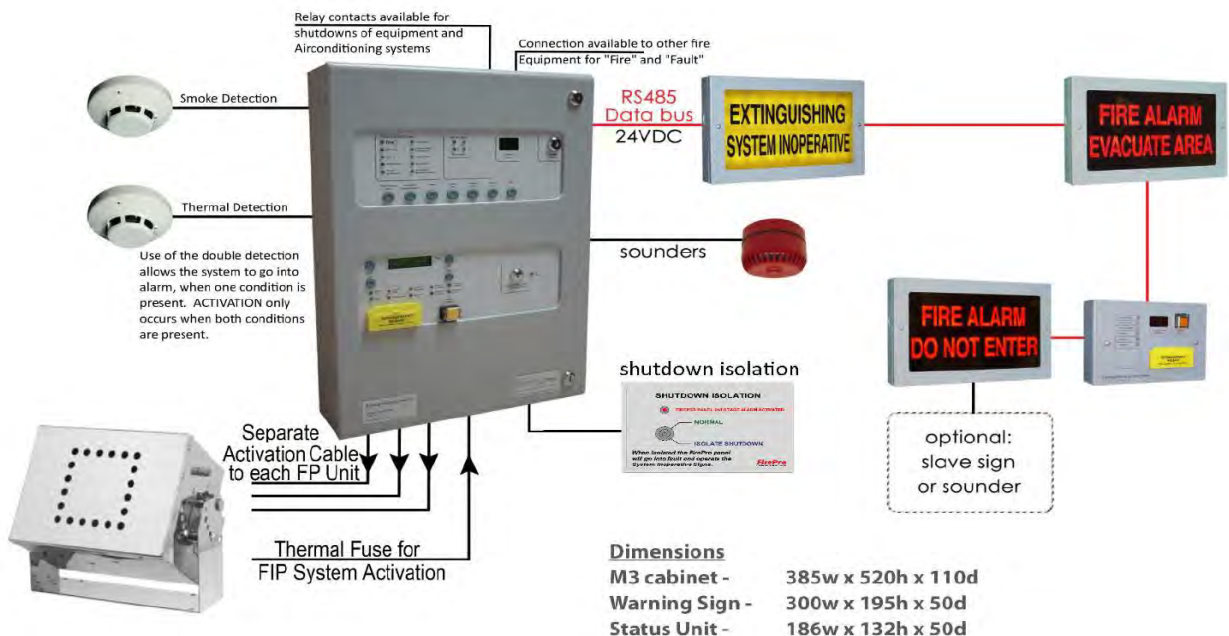

Fire suppression systems backed by **research**, committed to **people** and the **environment**



FP-90901 Local Control Station

Rev 1.2



Extinguisher Status Local Control Station Product Overview

LED indication of Manual Only, Automatic and Manual, Hold operated, Disabled, Imminent and Released conditions.

Local control of the Automatic/ Manual mode.

Monitored inputs for the remote connection of Automatic/ Manual mode and Hold switches.

A large, LED display which shows a countdown of the time remaining until the extinguishant is released in seconds.

Part No. 90901

Standard Features

- * High brightness LEDs
- * Indication of the status of the control panel
- * Monitored data connection
- * Countdown timer for agent release
- * Manual only and Automatic mode select
- * Four wire connection (data and power)
- * Protected dual action manual release switch
- * Common fault indication with buzzer
- * Robust, high quality enclosure
- * Easy access to terminals
- * Remote Hold input (monitored)
- * Internal fault diagnosis indicators
- * Internal buzzer

Technical Data & Standard References

Construction	1.2mm mild sheet steel
IP Rating (Standard unit)	IP30
Colour - lid & box	BS 00 A 05 grey - fine texture
Weight	1kg (all units)
Power supply	21 to 30 V DC
Maximum current draw	70 mA
Max. number of status units	7
Quiescent current	60 mA
Cable capacity	2.5mm ² per terminal
Monitored inputs end of line resistor	6K8 0.5W Resistor
Monitored inputs normal threshold	8K ohm to 1K ohm
Monitored inputs trigger threshold	700 ohms to 100 ohms
Monitored inputs Short circuit threshold	99 ohms to 0 ohms
data connection	RS485 connection (max 1200 m)
Size	256 x 170 x 60 (mm)

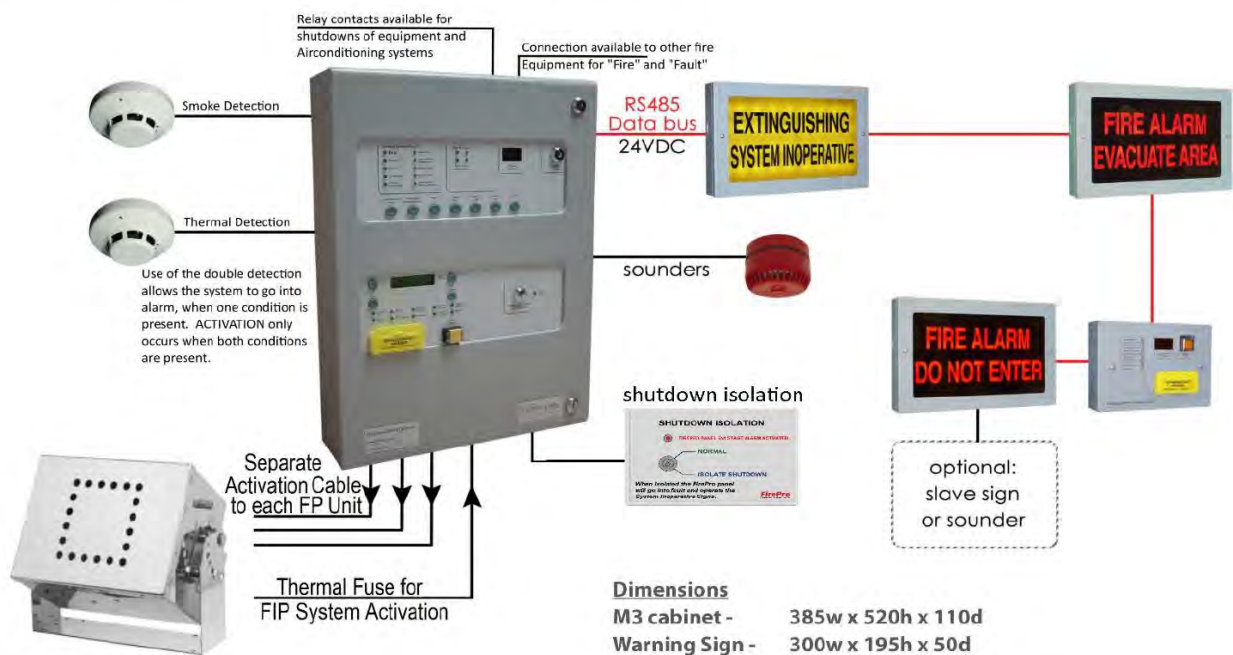

Fire suppression systems backed by **research**, committed to **people** and the **environment**



FPC-2

Fire Control Panel with Extinguishant Control Unit for Aerosol Release

Operation and Maintenance Manual

Issue 5.4

May 2020

Table of Contents

1.	Introduction.....	2
2.	Operation	2
3.	Installation and Mounting	3
3.1.	Connecting to the circuit board.....	3
3.2.	Power 24v IN – 24v OUT	4
3.3.	Detection zone wiring	4
3.4.	Sounder circuit wiring	4
3.5.	Connection of Aerosol Units to Activation circuit	5
3.6.	Connection to FirePro Units	5
3.7.	Indications	5
3.8.	Fault relay.....	5
3.9.	Fire relay	5
4.	Connecting to Master Fire Panel.....	6
4.1.	General.....	6
4.2.	FPC-2 as a sub-panel with stand-alone detection and activation	6
4.3.	FPC-2 as a activation Module only	6
5.	Panel Operation	7
5.1.	Silence Alarms.....	7
5.2.	Reset.....	7
6.	Power supply	7
7.	Maintenance	7
8.	Commissioning & Testing	7

1. Introduction

The FPC-2, a fire alarm control panel with Extinguishant Control Unit and Aerosol Agent Controller, is designed to comply with AS4487(2013) - Control and Indicating Equipment.

The control equipment is a combined fire alarm control panel and extinguishant system with one detection zones, and one extinguishant zone.

The FPC-2 Panel Protection Controller enables monitoring of detection and extinguishing circuits. The panel will support up to 4 FirePro aerosol generators.

The FPC-2 requires a battery backed 24V DC power supply capable of delivering 3A for a short period in order to operate the Aerosol Generators.

Volt free contacts are available to signal fire and fault conditions to plant or other monitoring equipment. Jumper links allow a signal to an addressable input module via a simple, 2 wire connection.

2. Operation

Under normal circumstances, the green Power On indicator will be lit, and the internal buzzer will be silent.

The wiring to the detection circuit and to the FirePro Aerosol Generators is supervised and disconnection of any of this wiring will be shown by illumination of the yellow Fault indicator on the front panel and operation of the internal buzzer. The internal fault volt free contact will operate and signal any external equipment that is connected to the controller Internal indicators are provided to show whether it is the detection circuit wiring or the wiring to the Aerosol Generators that has a fault.

The buzzer may be silenced by pressing the Buzzer Silence button.

Upon activation of a linear heat detection cable or smoke detector, the red Fire indicator will be lit, the FirePro Aerosol Generators will operate and immediately discharge extinguishing Aerosol into the protected area, the internal buzzer will sound and the Fault indicator will illuminate, indicating that the Aerosol Generators have fired and need replacing.

The internal fire volt free contact will operate and signal any external equipment that is connected to the controller. The buzzer may be silenced by pressing the Buzzer Silence button. Following a fire activation and replacement of the FirePro Aerosol Generators the system can be returned to normal operation by operating the Reset button on the front of the controller.

Note: The controller will continue to show a fault condition until the Aerosol Generators are replaced.

3. Installation and Mounting

This equipment is designed to be operated from 24V DC supply. This power supply must be battery backed. The FPC-2 should be effectively bonded to earth. Failure to ensure that all conductive accessible parts of this equipment are adequately bonded to earth will render the equipment unsafe.

This control panel is designed for indoor use only and at temperatures between -5°C (+/- 3) and +40°C (+/-2) and with a maximum relative humidity of 95%. Panels is rated to IP30 and suitable for mounting indoors.

Operation outside of these limits may render the equipment unsafe.

MOUNTING - The control panel should be mounted on a dry, flat surface, in a level position such that the enclosure is not distorted.

Suitable fixings of a minimum of 4mm diameter are to be used at all fixing points such that the control panel is securely mounted.

The panel should not be mounted in another enclosure or near sources of excessive heat.

Cables should be connected using cable glands fitted to the knockouts. If additional entry points are required, all swarf and debris caused by drilling of additional cable entries must be cleared before power is applied to the panel.

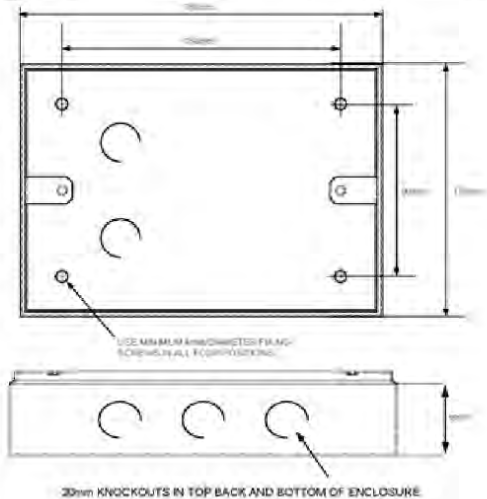

DIMENSIONS - 135H x 189W x 50D mm

Specifications

Mains supply	24V DC +10% - 15%
Mains supply fuse	1.6Amp (Quick Blow)
Operating Voltage	19-30V DC
Output voltage	19-30V DC +/- 2%
Standby Current	18mA
Extinguishant release output	19 to 30V DC. Fused at 1.6 Amp
Low Voltage limit	6V DC – at this point unit is operational will send fault signal to Sigma XT Panel
Extinguishant release	Immediate – Max 4 FirePro Aerosol units
Extinguishant release duration	Latched - Continuous
Detection Type	Hochiki Conventional PE smoke or Thermal Detectors – Max of 5 Detectors, can be mixed. Linear Heat Detection Cable - Latching Type NO – LHD Cable Max 30m
Detection Circuit End of Line	6K8 5% ½ Watt resistor
Fault relay contact rating	30VDC 1A Amp max
Fire relay contact rating	30VDC 1A Amp max
Cabling	FP200 or equivalent (maximum capacitance 1uF maximum inductance 1 millihenry)
Cable Entries	6 x20mm knockouts provided
Terminal capacity	0.5mm ² to 2.5mm ² solid or stranded wire
Construction	1.2mm steel – Epoxy Powder Coated

3.1. Connecting to the circuit board

All connections for field wiring are to a single row of terminals along the top of the circuit board.

Cabling must comply with the Australian Standards. The resistance of any cable must not exceed 25 ohms.

Terminals are capable of accepting wires of up to 2.5mm².

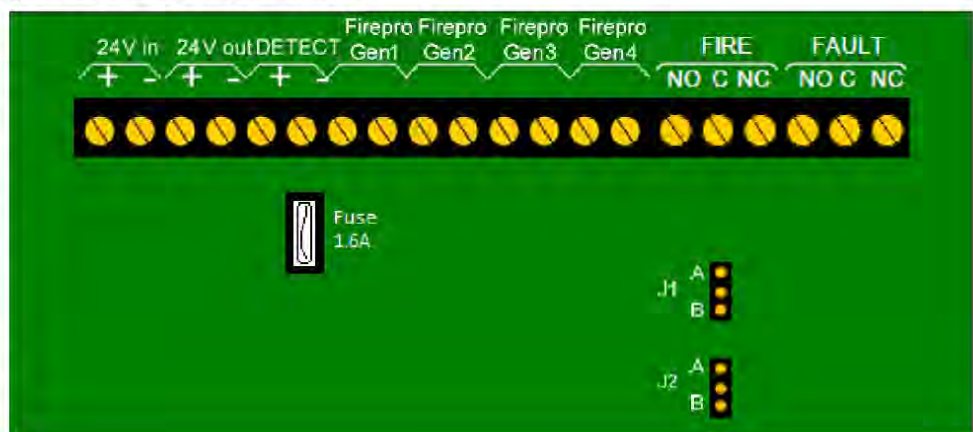

3.2. Power 24v IN – 24v OUT

The polarity of these terminals is very important. The 24V IN is for connection of the power from a previous unit or a power supply and the 24V OUT is for connection to further units.

Max Number of FPC-2 Units chained together is 3 using the power IN / OUT link. For additional units need to wire separately. Power supply will need to consider what current is required to ensure all devices operate correctly.

3.3. Detection zone wiring

These terminals are for the connection of a conventional type 24V smoke detectors or linear heat detection cable.

The wiring is monitored for open circuit faults.

The 6K8 end of line resistor are factory fitted to the control panel's terminals must be removed and placed across the last device that is wired to the circuit.

Detection circuit must be wired as a single, radial circuit with no spurs or T junctions to enable the monitoring circuit to work correctly.

Convention detectors may be mixed Thermal and Smoke.

A short circuit will create an ALARM condition.

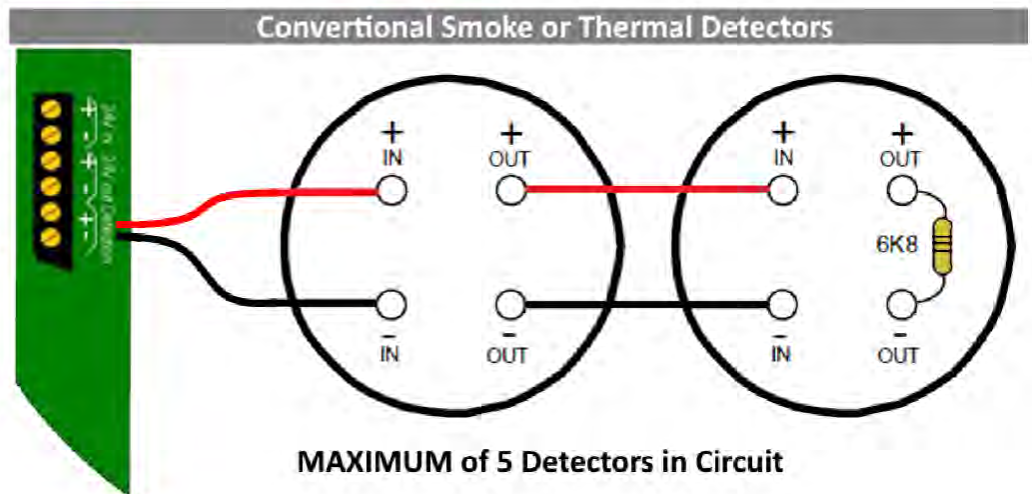
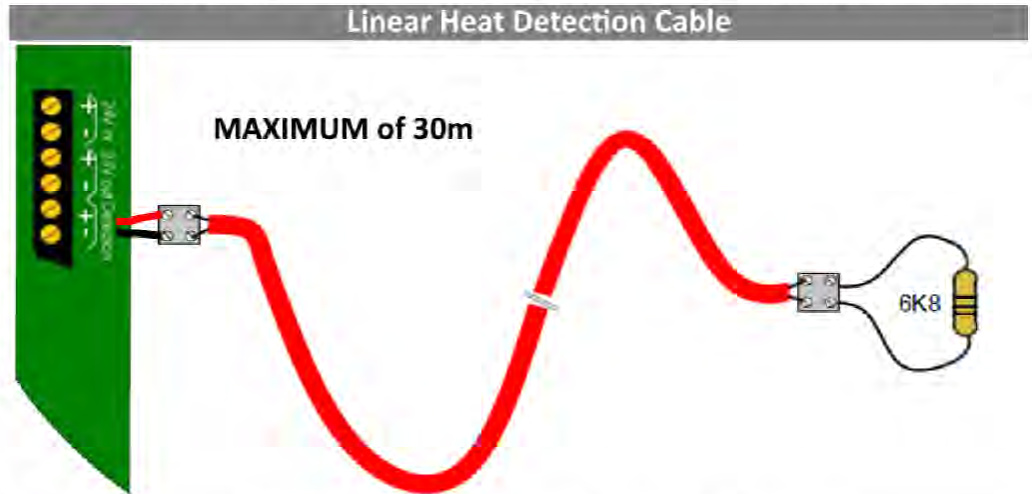

3.4. Sounder circuit wiring

There is no dedicated Siren circuit on this panel. Using the Fire Relay, a siren can be connected.

The "FIRE" terminal on the FPC2 is a relay that creates a closed circuit upon activation of the panel.

This can be used to activate a siren or other device.

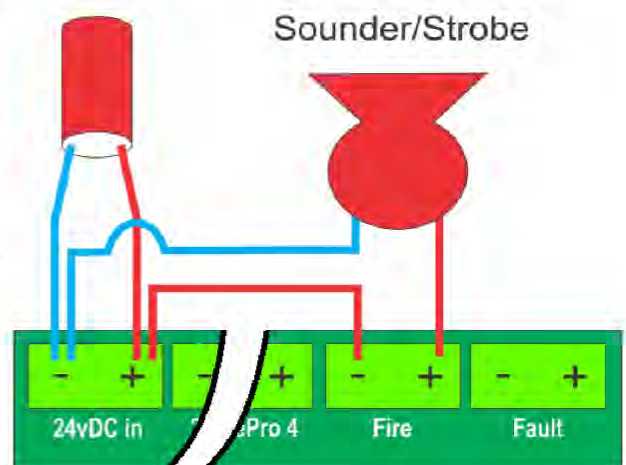

3.5. Connection of Aerosol Units to Activation circuit

These terminals are for the connection of FirePro® Aerosol Generators. Test lamps are provided in the terminals to allow testing of the system before connecting the FirePro® generators. These test lamps should be removed from the terminals if a FirePro® Aerosol Generator is to be fitted.

Any FirePro® generator outputs that are not being used should be left with test lamps fitted.

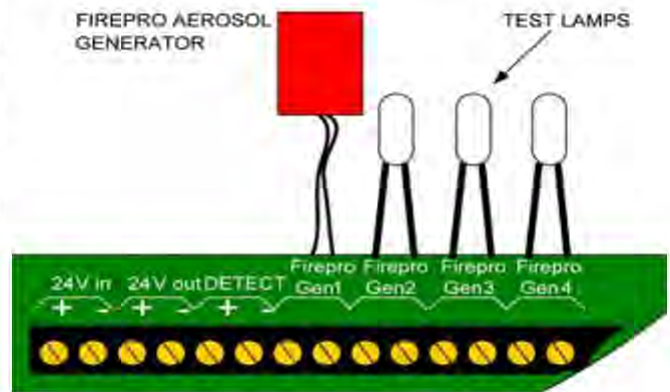

3.6. Connection to FirePro Units

When constructing leads to the FirePro units the supplied Deutsch Plugs must be used to ensure water-proof connections are made throughout the installation.

1. Cut cable to required length and strip outer insulation to approximately 50mm.
2. Strip inner insulation to approx. 6mm and using a Deutsch Crimping tool, fix pins to the exposed ends of the cable, including the earth.
3. Place heat shrink or rubber boot over the end of the cable. Identify correct socket on plug by the numbers/letter on the side of the plug and push through the gasket at the bottom of the plug until a click is heard and the pin is locked in place.
4. Place the locking wedge inside the plug to ensure pins remain secure. (Male plugs the locking wedge is orange. Female plugs the locking wedge is green)
5. Using the heat shrink and rubber boot, seal the back of the plug.

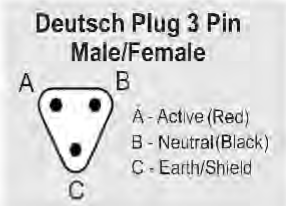

3.7. Indications

- | | |
|-----------------|---|
| Power Indicator | Operates as long as voltage is coming into panel – range is 12-30VDC. |
| Fault Indicator | Operates whenever any circuit fault is detected in the system. It is a common indicator for both the activation and detection circuits. |
| Fire Indicator | Operates when the detection circuit goes into alarm. |

3.8. Fault relay

The Fault Relay is normally energised and will de-energise upon any fault condition on the detection part or the extinguishant part of the control panel including total loss of power. Volt free changeover contact that will operate whenever there is a fault condition. This contact is rated for a maximum of 30V DC and 1Amp. These ratings must not be exceeded.

3.9. Fire relay

The Fire Relay will energise upon activation of a fire condition. The relay will remain activated until the control panel is reset. Volt free changeover contact that will operate whenever the system is triggered to alarm. This contact is rated for a maximum of 30V DC and 1Amp. These ratings must not be exceeded.

4. Connecting to Master Fire Panel

4.1. General

To connect to a Master Indicator Panel, there is some connections to be made between the panels and then some programming configuration in the Master Panel.

4.2. FPC-2 as a sub-panel with stand-alone detection and activation

Following explains connection and configuration to Sigma XT Master Panel. The concepts will be similar to other brands/types on master panel.

The connections are 24vDC power which can come from Sigma XT – or an appropriate external source, and a Single detection Zone is require on Sigma to allow inputs from FPC-2.

The EOL Resistor ensures that this circuit is monitored from the Sigma XT panel.

Once the connections are complete. The Sigma XT panel must be programmed correctly to set up the FP-C2 as a remote device. This must be done so that the FP-C3 is not treated as a regular detection device. When programmed correctly, the FP-C2 will alert the main Sigma XT panel of any alarm or fault states.

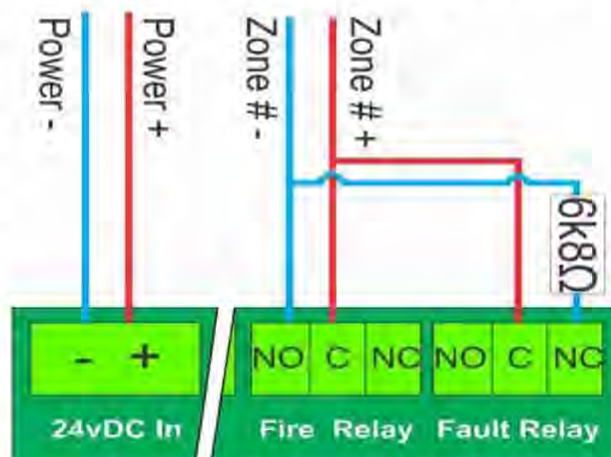

On the Sigma XT FIP, enter Access Level 2 by turning the key in "Enable Control" port on the Detection card (top card) or by releasing the read switch by opening the inner Perspex door.

6. Enter Access level 3 on the Detection Card (top card) by moving the "Write Enable" switch to the right. The "System Mode" LCD display will read "00".
7. The FIP's detection options are numbered. Using the controls on the Detection Card, navigate the menu until the "System Mode" LCD display reads "7#" (# being the number of the detection circuit you wish to connect to). To do this press the "Mode (+10)" button until the first number is "7" and then press the "Select (+1)" button until the display shows the correct detection circuit.
8. The detection circuit number will have a flashing dot next to the number, indicating that it is programmed for conventional detection. Press the "Enter" button to change the detection circuit to S/C mode. This will cause the flashing dot to turn off.
9. Exit Access level 3 by moving the "Write Enable" switch to the left and exit Access level 2 by closing the inner door or by turning the key in the "Enable Control" port.

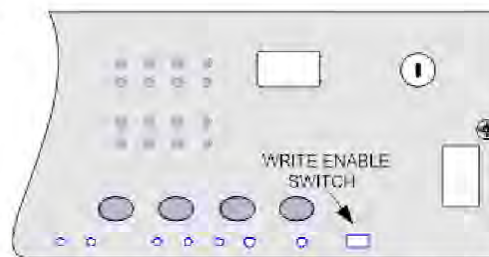

4.3. FPC-2 as a activation Module only

This configuration uses the FPC-2 as an activation module only. This can be established with any style of AS Panel. Individual configurations will be dependent on the specifics of the master panel.

Connection will be required for the Power Supply. The activation device needs to connect to the detection circuit on the FPC-2, this needs to meet the detection circuit criteria. Once the FPC-2 receives a detection advice – activation of the extinguishant system is immediate.

Fire and Fault reporting will require connection back to the master panel.

To make the FPC-2 compatible with an addressable input module, move jumpers J1 and J2 from their default positions (position A) to position B. The FIRE NO and C terminals can now be connected directly to the addressable input module.

Alarm and fault conditions will be indicated on a addressable fire alarm control panel.

Note: The volt free contact function is not available when the contacts are being used to signal and addressable input module.

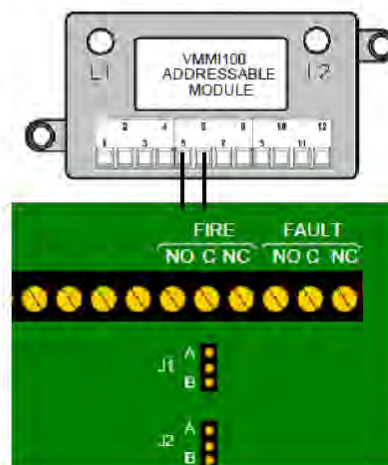

5. Panel Operation

5.1. Silence Alarms

The *Silence/Sound alarm* button will only silence the buzzer in the FPC-2 unit.

5.2. Reset

To *Reset* button is a full reset on the FPC-2 panel only.

6. Power supply

The control panel requires 24v DC.

Exceeding the maximum power supply rating may cause a fuse or other protective device to operate and render the equipment inoperative until the fuse is replaced or protective devices are reset.

7. Maintenance

FPC-2 control panels do not require any specific maintenance but should the control panel become dirty it can be wiped over with a damp cloth and should then be dried with a dry, lint free cloth. Detergents or solvents should not be used to clean the panel and care must be taken that water does not *Enter* the enclosure.

Testing of the extinguishant system should only be carried out by trained personnel and must be done with appropriate isolation measures in place to ensure that accidental discharge of the extinguishant agent is avoided and any malfunction should be reported to the fire alarm maintenance company immediately.

8. Commissioning & Testing

Before applying power to the panel, igniting actuators must be physically isolated from the system by disconnecting both wires to it. This will prevent any accidental release of extinguishant.

When power is applied, if all connections are correct, only the green Power should be lit. If any fault indicators are lit the wiring to the appropriate input or output should be checked and all faults have been cleared before proceeding.

TESTING

DISCONNECT ALL FIREPRO AEROSOL GAS GENERATORS BEFORE TESTING.

Do not leave any FirePro gas generators connected to the unit when testing or these units will activate.

TO TEST SYSTEM:

- Step 1 Turn Power off
- Step 2 Disconnect FirePro units and connect test lamps
- Step 3 Visually inspect each FirePro unit installed and ensure BKF and mounting bolts are intact. The FirePro® unit must be clean and free of debris
- Step 4 Inspect all other component detectors, sirens etc. Inspect cable for any signs of damage.
- Step 5 Turn power on to panel and test detection system to simulate activation-all test lamps to be lit.
- Step.6 Turn off power – Reconnect all FirePro units
- Step.7 Turn power on – Testing is complete

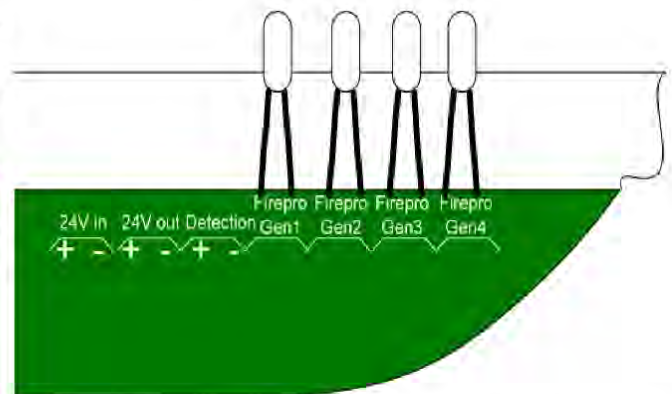

Note: If the system has been activated the system activation fuse needs to be inspected as blown fuse will show as a fault. The Fuse is 1.6AMP Quick Blow.

5.4. FP-0100S Firepro Aerosol Generator



■ FP-100S
Product Code: 10140
Product Description: FirePro
Fire Extinguishing Generator FP-100S.
Features:
 • UL, KIVA, BSI, ActivFire Approved

TECHNICAL INFORMATION

Model	FP-100S
Activation mechanism	Thermal Electrical (min 1.5V DC, 0.8A in 3-4 sec)
Activator type	Heating element with 2.3 ohm resistance
Current intensity to be tested	Maximum 5 mA
Weight (gross)	1370 g (excluding bracket)
Mass of FPC compound	100 g
Operational discharge time	5 - 10 seconds
Discharge length	1 m
Dimensions (Height: Diameter)	155 mm : 84 mm (incl. connector housing)
Fire class	A, B, C, F

Operating temperatures: -54°C to +54°C | Generators are provided complete with brackets

© 2011 FirePro. FirePro.

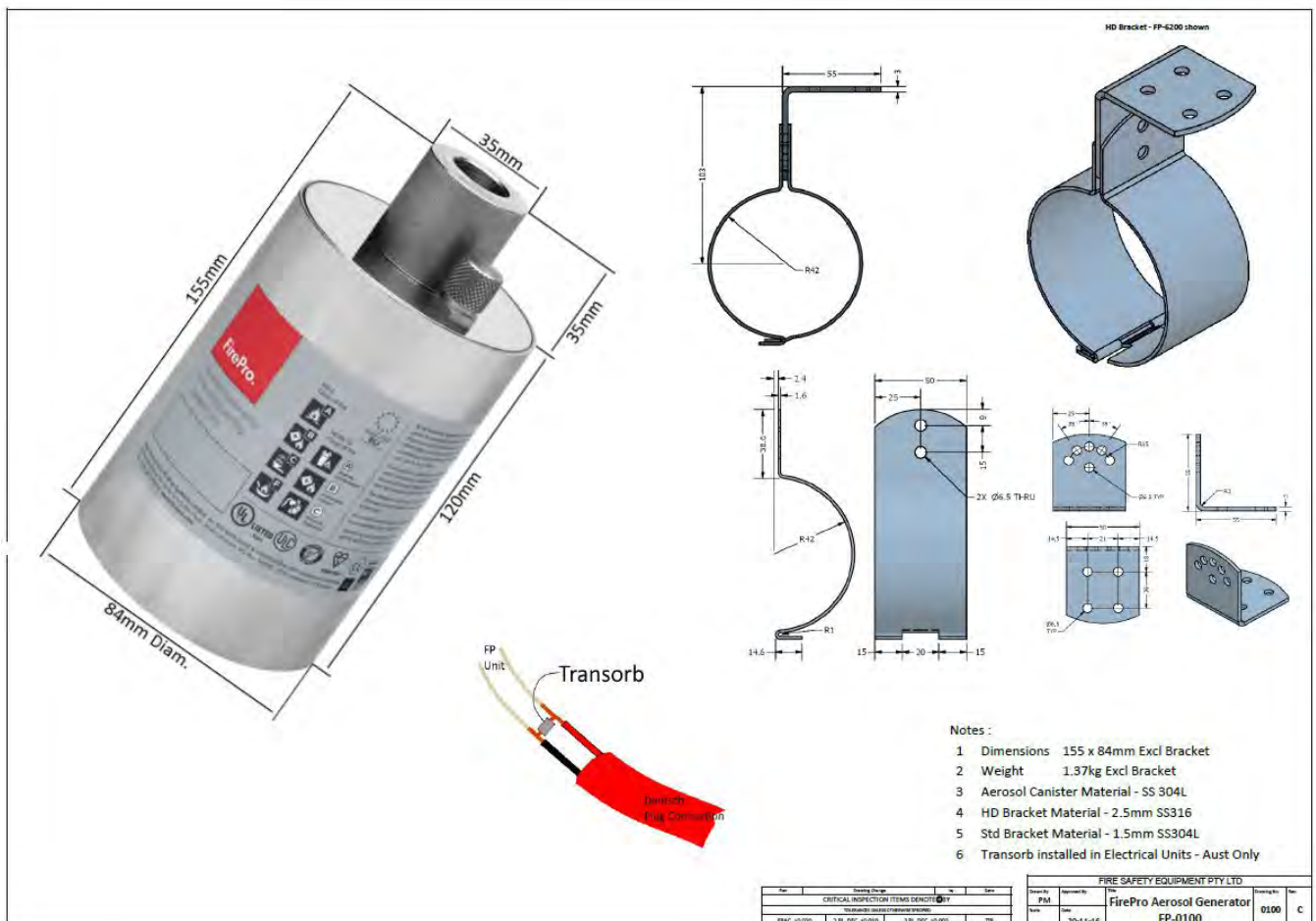

5.6. FP-0500S FirePro Aerosol Generator



■ FP-500S

Product Code: 10145

Product Description: FirePro

Fire Extinguishing Generator FP-500S.

Features:

- UL, KVA, BS, ActiveFire Approved

TECHNICAL INFORMATION

Model	FP-500S
Activation mechanism	Thermal Electrical (min 1.5V DC, 0.8A in 3-4 sec)
Activator type	Heating element with 2.3 ohm resistance
Current intensity to be tested	Maximum 5 mA
Weight (gross)	3340 g (excluding bracket)
Mass of FPC compound	500 g
Operational discharge time	5 - 10 seconds
Discharge length	3 m
Dimensions (Height : Diameter)	295 mm : 84 mm (incl. connector housing)
Fire class	A, B, C, F

Operating temperatures: -54°C to +54°C | Generators are provided complete with brackets

Product Catalogue **FirePro.**

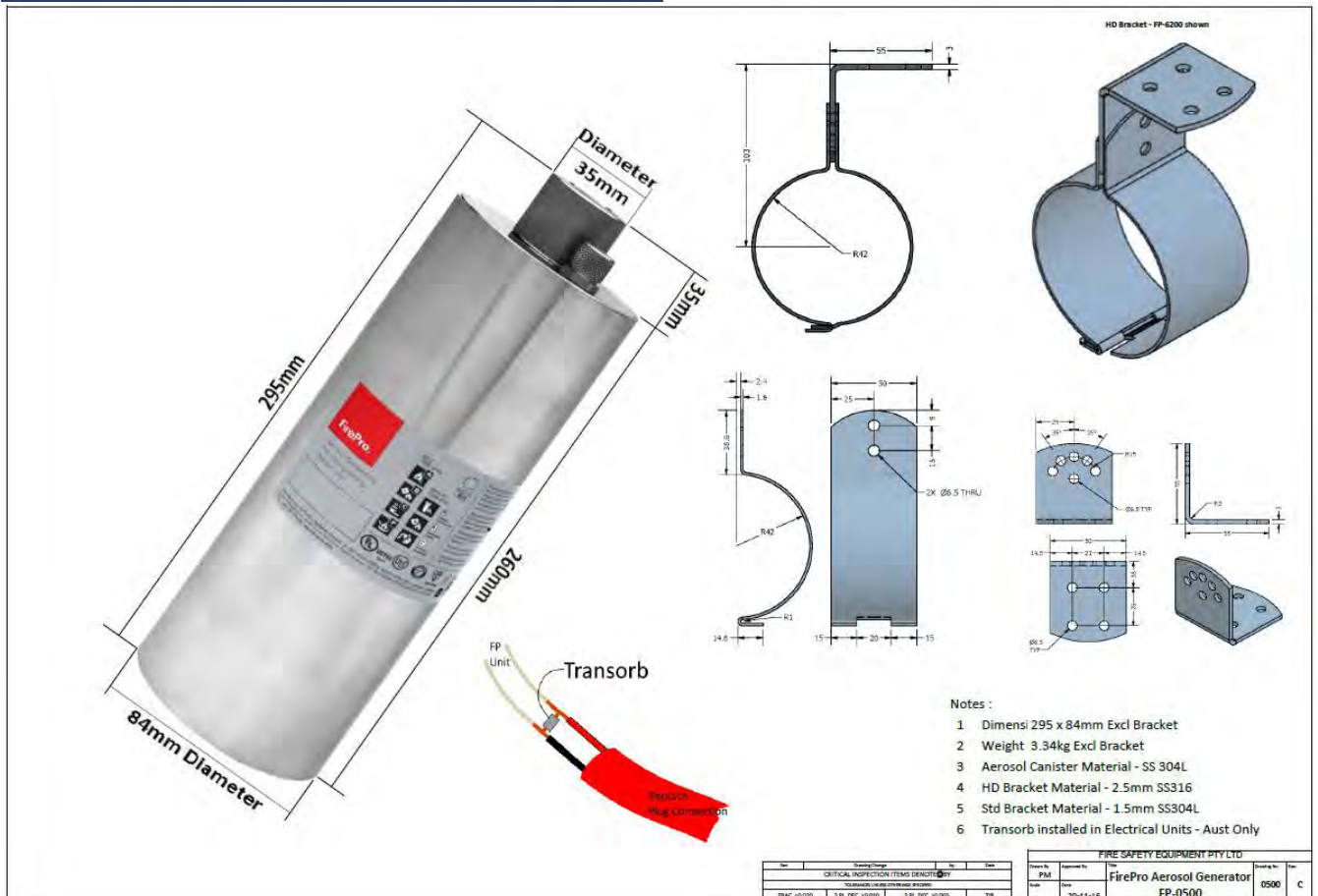

5.7. FP-3000S Firepro Aerosol Generator



■ FP-3000

Product Code: 10150

Product Description: FirePro Fire Extinguishing Generator FP-3000.

Features:

- UL, KiWA, BSI, ActivFire Approved
- Carbon-Steel casing Red-coated

■ FP-3000T

Product Code: 10318

Product Description: FirePro Fire Extinguishing Generator FP-3000T.

Features:

- Under Process to be UL, KiWA, BSI, ActivFire Approved
- This model can be activated by a Built Thermal Activator
- Carbon-Steel casing Red-coated

■ FP-3000S

Product Code: 10393

Product Description: FirePro Fire Extinguishing Generator FP-3000S.

Features:

- UL, KiWA, BSI, ActivFire Approved
- Stainless steel casing

■ FP-3000TS

Product Code: 10624

Product Description: FirePro Fire Extinguishing Generator FP-3000TS.

Features:

- Under Process to be UL, KiWA, BSI, ActivFire Approved
- This model can be activated by a Built Thermal Activator
- Stainless steel casing

TECHNICAL INFORMATION

Model	FP-3000 / FP-3000S / FP-3000T / FP-3000TS
Activation mechanism	Thermal Electrical (min 1.5V DC, 0.8A in 3-4 sec)
Activator type	Heating element with 2.3 ohm resistance
Current intensity to be tested	Maximum 5 mA
Weight (gross)	16300 g (excluding bracket)
Mass of FPC compound	3000 g
Operational discharge time	15 - 20 seconds
Discharge length	4 m
Dimensions	300 mm x 300 mm x 185 mm
Fire class	A, B, C, F

Operating temperatures: -54°C to +54°C | Generators are provided complete with brackets

Product Catalogue **FirePro.**

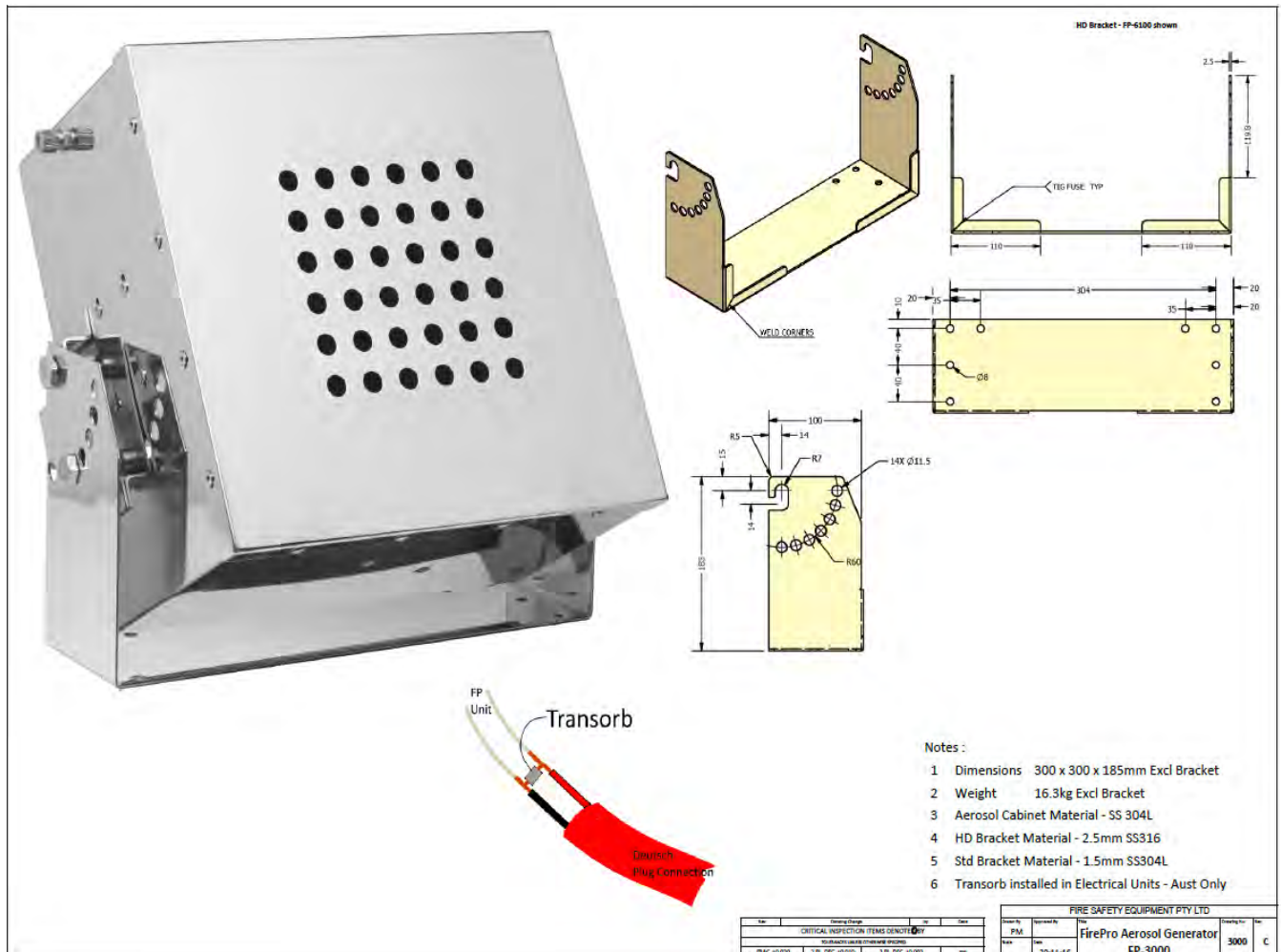

5.8. Conventional Detectors - PE Smoke & Thermal

DETECTORS for use with SIGMA FIP



Conventional Combined Rate of Rise & Fixed Temp Heat Detector (60°C)

FP-94210

Rate of Rise Heat Detector with a 60°C fixed temperature element using a thermistor and linearising circuit to provide an accurate linear response Heat Detector. Ideal for use where medium ambient temperatures exist, such as drying rooms or where Smoke Detectors are unsuitable because of the presence of steam or cooking fumes such as in a kitchen. (DCD-A3)

Conventional Combined Rate of Rise & Fixed Temp Heat Detector (90°C)

FP-94220

Rate of Rise Heat Detector with a 90°C fixed temperature element using a thermistor and linearising circuit to provide an accurate linear response Heat Detector. Ideal for use where medium ambient temperatures exist, such as drying rooms or where Smoke Detectors are unsuitable because of the presence of steam or cooking fumes such as in a kitchen. (DCD-C3)

Conventional Photoelectric Smoke Detector

FP-94240

The SLV-AS3 incorporates Hochiki's unique High Performance photoelectric smoke chamber removing the need to use Ionisation Detectors in the majority of applications. This also allows the Detector threshold level to be increased, thereby improving the signal to noise ratio and reducing susceptibility to false alarms. (SLV-AS3)

Detector Base

FP-94200

Conventional Detector Mounting Base associated with the CDX Range of Detectors and is fully compatible with the majority of existing conventional fire alarm control panels. It is supplied with square cable clamps for secure and reliable cable termination but the base does not provide line continuity during detector removal, therefore if Call Points are being used then these should be wired onto the zone first. (YNB-R6)



Features :

- Wide voltage range (9.5 ~ 30Vd.c.)
- Remote Indicator output
- Low profile design with one piece outer cover
- Twin fire LED's allow 360° viewing

Specifications			
Ordering Code	FP-94210 DCD-A3	FP-94220 DCD-C3	FP-94240 SLV-AS3
Operating Voltage	9.5 - 30Vd.c.		
Quiescent Current (typ)	35µA		
Maximum Current in Alarm	80mA		
Remote Indicator Drive	20mA (max) / 9.5-14mA (typ)		
Maximum Humidity	95%RH - Non Condensing (at 40°C)		
Ingress Protection Rating	IP63		IP42
Colour / Case Material	White / Polycarbonate		White / ABS
Weight (g) / Diameter (mm) / Height (mm)	76 / 100 / 38		75/100 / 46
Compatible Bases / Base Height	FP-92400 (YBN-R6) / 8m		
Base Fixing Centres (mm)	48 ~ 74		
Approvals	AS7240.5	AS7240.5	
	Class CR	Class A1R	

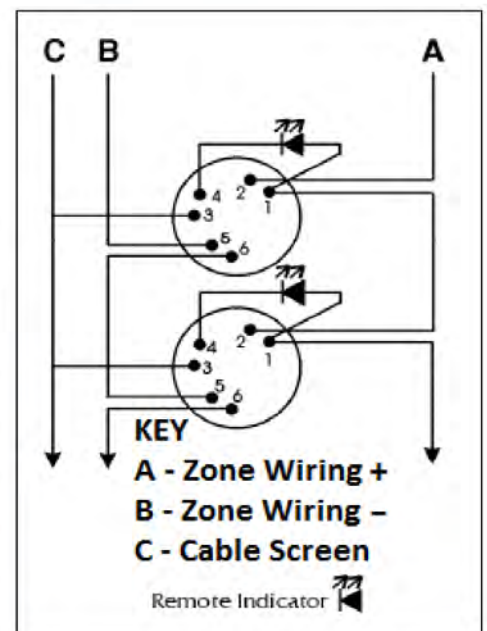



Reinventing Fire Suppression

Linear Heat Detection Cable Model 09510

Rev 2.0

1 Introduction

1.1 General Information

Linear Heat Detection (LHD) is a line-type form of fixed temperature heat detection that can be used in a variety of applications including vehicle, marine and industrial risks.

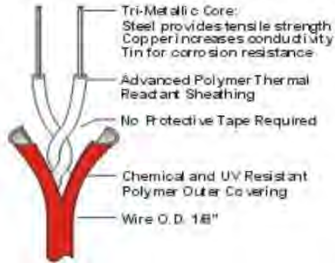

This linear cable can detect a fire anywhere along its entire length.

LHD Cable detection systems are easy to design, install, operate and maintain. Up to 100m of LHD Cable can be used on every zone of any approved conventional panel.

A low current is run through the cable which is monitored by the control panel. In a fire the LHD insulation will breakdown and make contact, signalling the control panel of an alarm.

1.2 How Does it Work

LHD Cable works using a twisted pair of extremely low resistance, tri-metallic conductors sheathed in advanced thermal polymers. When a fire occurs, the heat generated causes the internal thermal polymer insulation to melt. This allows the conductor wires to contact, creating a short circuit that signals an alarm.



2 Components List

Linear Heat Detection Cable



FP-09510
Linear Heat Detection Cable 185° C

Install Kit



FP-09515
P Clip

1x DP-2000

Deutsch Plug 2 Pin M/F, c/w heatshrink

Termination Options



DP-2000
Deutsch Plug 2 Pin M/F, c/w heatshrink



FP-09512
2way and EOL Junction Boxes with strain relief cable glands and 1x EOL for monitoring. (Obsolete)

Note: Standard detection temperature is 185°C. Different temperature detection cable available upon request.

Note: FP-09512 Junction boxes have been made obsolete and are to be used only in existing installations. Where installations are found to use Junction Boxes it is recommended to replace these with DP-2000 Deutsch Plug 2 Pin.



3 Design Considerations

3.1 Mounting Location

LHD Cable is to be installed on a smooth surface avoiding any obstructions that may inhibit detection, with appropriate clearance/protection from:

- Heat sources that may cause false alarms (e.g. exhaust manifold, turbo, etc)
- Moving parts or articulating joints
- Large amounts of water
- Corrosive chemicals

Using DP-2000 Deutsch Plugs, the LHD maintains an IP68 rating and is UV, oil and chemical resistant, however sources of these should be avoided to extend the life of the LHD cable and avoid false alarms. Where these cannot be avoided, FP-09500 Fire Rated Cable may be used to make extension leads to bypass these hazards and reduce any damage to the LHD.

3.2 Installation Requirements and Limitations

For total coverage, LHD should be looped around the risk area with spacing between cable no more than 600mm apart. The bend radius must never be less than 150mm.

The maximum length of a continuous run of LHD is 100m metres. This includes any extension leads or manual actuators that may be included in the circuit.

LHD cable should never be installed in a high tension state as this may cause damage to the internal conductors and cause false alarms. A service loop should be included to allow for normal expansion and contraction of the LHD due to temperature.

LHD cable must be mounted using only approved P Clips at minimum every 500mm. Additional P Clips should be used where necessary, particularly in high vibration or aggressive environments. P Clips are to be used to support bends and to prevent excessive sagging. Use of non-approved fasteners may damage the LHD.

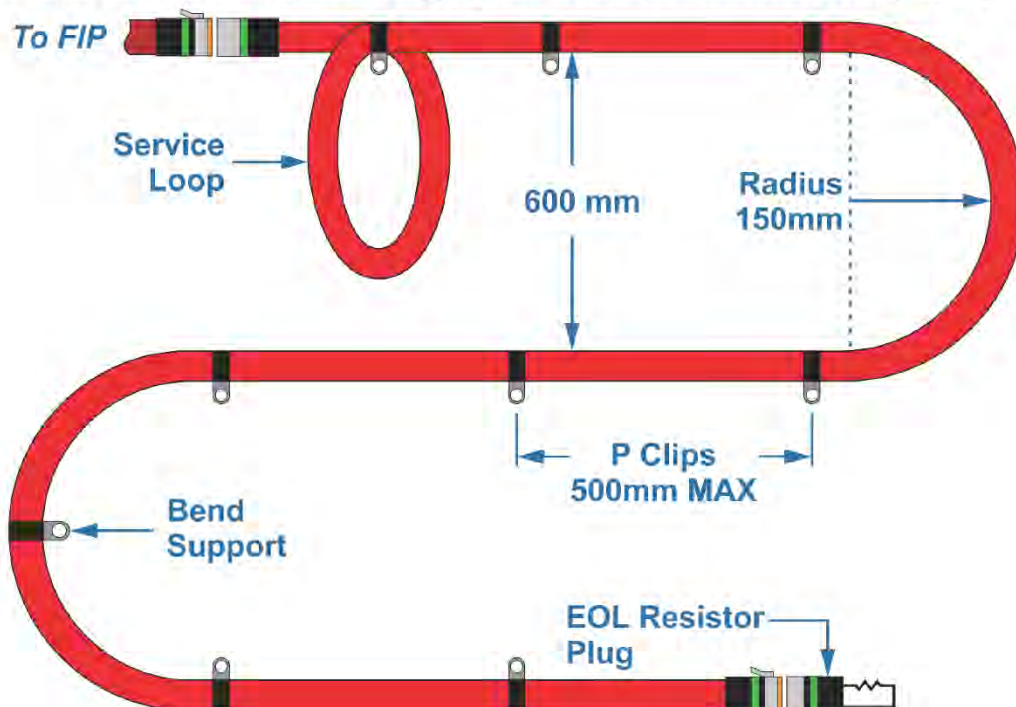

To avoid damage or failure, LHD cable **must not**:

- be bent using tools or kinked when installed
- be painted
- enclosed in conduit, ducting or other exterior protection
- be spliced into – only continuous runs connected using the supplied Deutsch Plugs may be used

If the LHD cable is damaged by fire, the whole length must be replaced.

FirePro generators **must** remain disconnected until system is completed and fire control panel is no longer in a fault or alarm condition. The FirePro Universal Test Lamp (P/N FP-08800) can be used to take the panel out of a fault condition.

Any required extension leads **must** be constructed as per the instructions in 3.3 Cabling Requirements.

3.3 Cabling Requirements

When constructing extension leads the supplied Deutsch Plugs must be used to ensure water-proof connections are made throughout the installation.

1. Cut cable to required length and strip outer insulation to approximately 25-30mm.
2. Strip inner insulation to approximately 6mm and using a Deutsch Crimping tool, fix pins to the exposed ends of the cable, including the earth where applicable.
3. Place heat shrink over the end of the cable. Identify correct socket on plug by the numbers/letter on the side of the plug and push through the gasket at the bottom of the plug until a click is heard and the pin is locked in place.
4. Place the locking mechanism inside the plug to ensure pins remain secure. (Male plugs; locking mechanism is orange. Female plugs; locking mechanism is green).
5. Using the heat shrink, seal the back of the plug.

Cables are colour coded for easy identification. When installing system, cables should be only connected to the correctly coded cable. Colour Coding for cables is as follows:

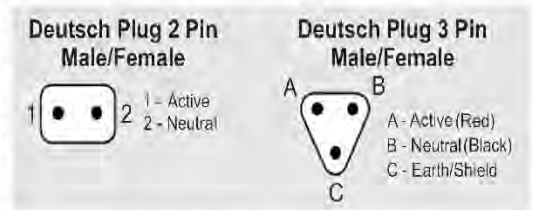

Colour	Circuit
Red	Power Supply
Yellow 1	Activation
Yellow 2	Activation Delayed
Green 1	Detection 1
Green 2	Detection 2
Orange	Siren/Strobe
White	Relay Output

4 Servicing and Maintenance

Inspection and servicing of the installed fire system should occur in accordance with the relevant Australian Standards (i.e. AS1851 or AS5062).

Note: No servicing should be performed, and no personnel should be in the risk area until the fire system is fully isolated.

1. Visually inspect the LHD cable. Ensure that the routing and installation procedures comply with the guidelines described in this document.
2. Ensure that there has been no damage to the cable, plug connections or junction boxes.
3. Isolate the fire suppression system and simulate an alarm condition on the detection circuit. This is done by closing the circuit where the linear end of line module is located by using a jumper wire. Verify the fire system enters an alarm condition and reset the control panel.

Note: Do not test LHD cable using a heat source. LHD cable must be replaced after every heat detection event.

5 Specifications

Maximum Run Length	100 metres
Resistance	0.164 ohms/metre
Maximum Voltage Rating	30vDC
Maximum Ambient Temperature	152° C
Standard Activating Temperature	85° C
Optional Activation Temperatures	- 68° C - 88° C - 105° C
Weight	0.0223kg/metre
Diameter	3.2mm
Bend Radius	76.2mm
Outer Sheath Material	Polymer



Flashni Combined Sounder Strobe

The FP-08940 Sounder Strobe is a combined sounder strobe (beacon) which requires one single installation point. This greatly reduces installation costs and is much less obtrusive than two separate devices.

Providing an audio-visual warning, the unit combines the features of a Roshni electronic sounder with a fully integrated Xenon beacon. It is suitable for installation in internal or external locations where a combination of high sound output and visual indication is required. It is available with a shallow or deep base.

Features :

- 32 tones (user selectable)
- High output sounder beacon
- Automatic sounder synchronization
- Volume control
- Lockable base

Electrical & Mechanical Data

Voltage:	9 – 28Vdc
Current:	110 mA @12V DC 70mA @ 24V DC
Sound Output:	101dB(A)
Beacon:	0.7j
Flash Rate:	60/min (1Hz)
Temperature:	-10 C to +55 C
IP Rating:	IP54 (Full-R-D-Base Required for IP65)
Lens Colour:	Red
Body Colour:	Red

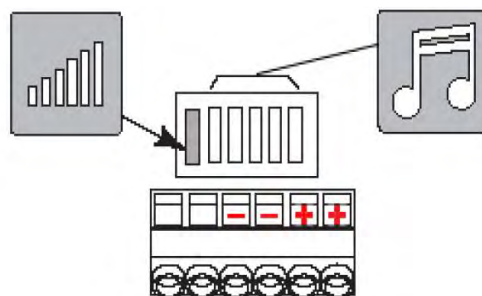
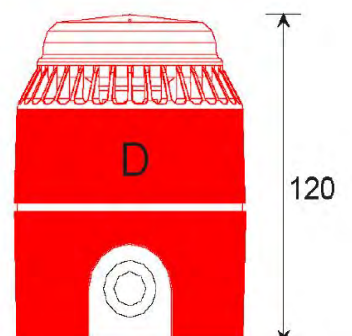
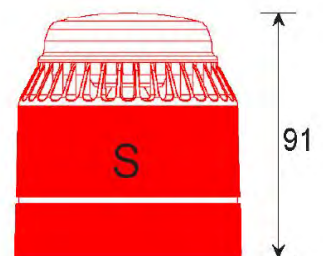
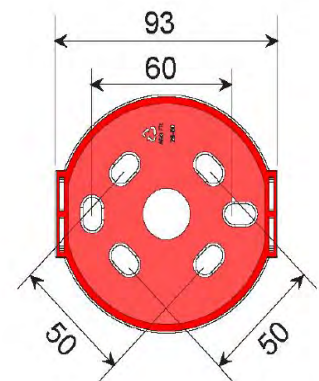

5.11. Warning Signs

Indoor Warning Signs

Part No: FP-92300



Part No: FP-92400



Part No: FP-92500



Weatherproof Warning Signs

Part No: FP-92100

Part No: FP-92200

Part No: FP-92600

FEATURES

- Matches design and colour scheme for Sigma XT FIP
- High Brightness LEDs
- Split level function
- Multiple signs per circuit(dependent on supply voltage)
- Internal Buzzer with disable function

Technical Data

	INDOOR	WEATHERPROOF
Power	15-30VDC	
Current – Max	140 mA	
Current -Quiesant	20 mA	
Construction	1.2mm mild sheet steel	Base Thermoplastic
Colour	BS 00 A 05 grey texture	Lid polycarbonate
IP Rating	IP40	IP55
Size	300 x 195 x 50	300 x 220 x 75

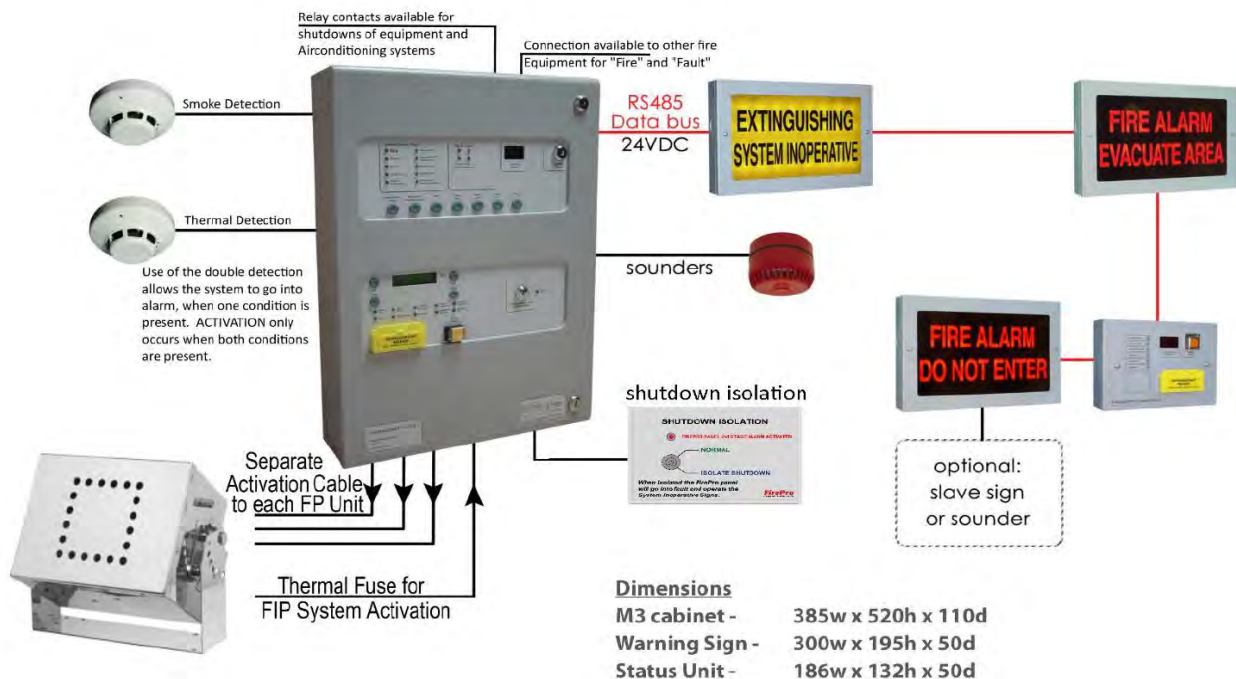



FP-09500 Fire Rated Screened Cable

Rev 1



RAMFireCRO-F3 - Fire Resistant Cable, low smoke, Halogen Free

Application

Suitable for the connection between the sensors and the control of fire detection systems are required when special features such as: fire resistance, reduced emission of opaque smoke, the reduced emission of toxic and corrosive gases and halogen-free.

Technical Data & Standard References

Fire Performance	EN 50200 PH120 IEC 60331-21
Test on Single Cable	IEC 60332-1
Test on Bunched Cables	IEC 60332-3
Limiting Oxygen Prefix	Min 37%
Smoke Density	IEC 61034
Amount of halogen acid gas	IEC 60754-1 Max 0.5%
Acidity (PH value) and conductivity	IEC 60754-2

Construction

Formation	2 Core
Conductor Cross Section	0.75mm ²
Conductor	Plain Annealed copper wire, multistrand
Insulation	Special mix Silicon Rubber
Colour Code	Black, Red
Wrapping	I layer plastic tape 0.023mm
Collective screen	0.026mm Aluminium / PETP tape over tinned copper drain wire
Outer Sheath	THERMOPLASTIC Low Smoke, Halogen Free – LSZH - Red
Outer Diameter (nominal)	6.3mm

Electrical & Mechanical Data

DC Resistance per Core at 20°C	Max 27.1 Ω/km
Insulation Resistance at 20°C	Min 200 MΩ*km
Mutual Capacitance	Max 115 nF/km
Inductance	Max MH/km 1
Test Voltage Core / Core /Screen	2000 V
L/R Ratio	Max 25 μH/Ω
Operating Voltage	300 V
Temperature Range	-40°C to +75°C
Minimum Bend Radius	50mm
Weight Approx	61kg / km





Reinventing
Fire Suppression

Wiring Looms Splitter Cables

Rev 1.3

WIRING LOOMS

Systems are prepared using wiring Looms. These looms use 0.75mm stranded class 5 shielded fire Rated Cables. These are coloured red in accordance with Australian Standards for fire systems. The cables are colour coded using coloured cable ties:



The connections are made using Deutsch Plugs(DT Series) and these are provided in the kit for each system

SPLITTER CABLE

Where multiple FirePro generators are used, the activation splitter cables can be used. These are fitted in the cable assembly – this is important for the monitoring and activation circuits.



DEUTSCH PLUGS – DT Series

Deutsch Plugs (DT Series) environmentally sealed connectors are designed specifically for cable to cable applications. The connectors are suitable for harsh environment applications where even a small degradation in connection may be critical. Thermoplastic housings offer a wide operating temperature range -55°C to 125°C and silicone rear wire and interface seals allow the connectors to withstand dust and moisture rated to **IP68**. Suitable for up to 13 amps continuous. Contacts: Copper Alloy, Nickel Plated

DT series have been successfully tested to the 20 mm Flammability Test per Standard UL-94.



For crimping the connector pins we recommend using the correct Deutsch Crimping tool as shown.



PS12100 Specifications

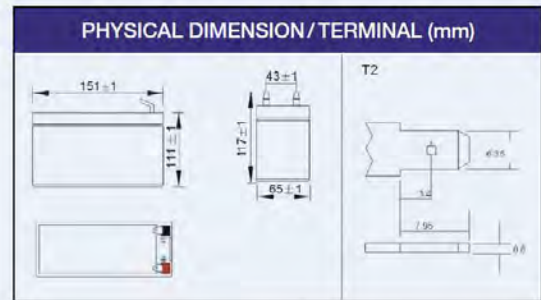

DISCHARGING CURRENT & DISCHARGE DURATION TIME

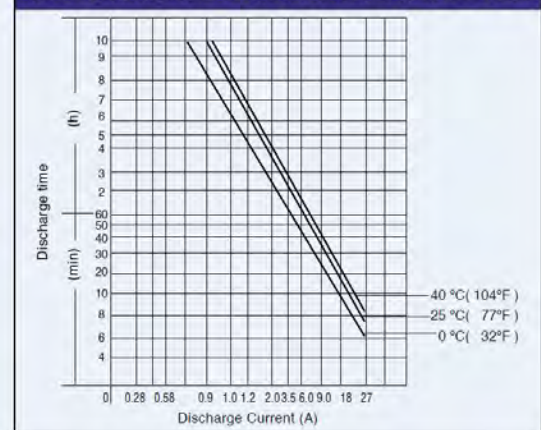

PHYSICAL SPECIFICATION		
Nominal Voltage		12V
Nominal Capacity (20HR)		10AH
Dimension	Length	151 ± 1mm (5.95 inches)
	Width	65 ± 1mm (2.56 inches)
	Container Height	111 ± 1mm (4.37 inches)
	Total Height (with Terminal)	117 ± 1mm (4.61 inches)
Weight		Approx 3.30kg (7.28lbs)
Terminal Type		T2

ELECTRICAL SPECIFICATION					
Rated Capacity	20 hour rate (500mA)	10.00AH	Constant-Voltage Charge	Cycle	Initial Charging Current less than 3.6A. Voltage 14.4V-15.0V at 25°C (77°F) Temp. Coefficient -30mV/°C
	10 hour rate (930mA)	9.3AH			
	5 hour rate (1.70A)	8.5AH			
	1 hour rate (6.20A)	6.2AH			
	15minute rate (19.6A)	4.9AH			
Capacity affected by Temperature	40°C (104°F)	103%	Standby	No limit on Initial Charging Current Voltage 13.5V-13.8V at 25°C (77°F) Temp. Coefficient -20mV/°C	
	25°C (77°F)	100%			
	0°C (32°F)	86%			

DISCHARGE CHARACTERISTICS (25°C, 77°F)

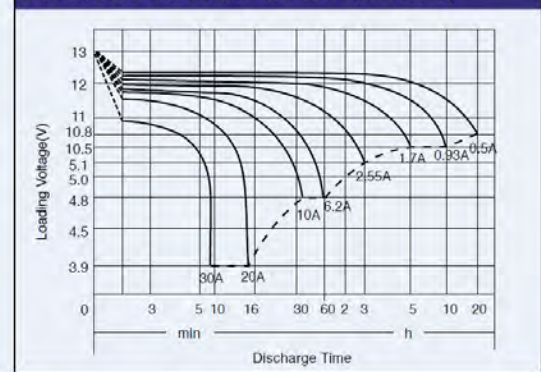

CONSTANT CURRENT (AMP) AND CONSTANT POWER (WATT) DISCHARGE TABLE 7°F

Time (minute) / Final voltage/Cell	5	10	15	20	30	45	60	120	180	300	600	1200
Amp/Watt	1.3	1.3	1.3	1.3	1.6	1.6	1.67	1.7	1.75	1.75	1.75	1.8
A	40.00	28.50	19.60	16.00	11.50	8.00	6.20	3.50	2.55	1.70	0.93	0.50
W	71.60	53.60	37.30	31.30	22.60	15.90	12.30	6.96	5.07	3.40	1.86	1.01

Trade Enquiries 1300 362 287
www.centurybatteries.com.au



6. Compliance Certificates & Commissioning Reports

6.1. ASC01



Reinventing
Fire Suppression

CERTIFICATE OF COMPLETION & CONFORMITY

I/We (name of installer) of (company name) hereby certify that we have completed a FirePro aerosol fire extinguishing installation/extension(s) in accordance with AS4487, as designed by (company name).

Name of Client : **Kalmar Equipment Australia Pty Ltd.**
Address of Protected Area : Moorebank Intermodal – ASC01
Description of Protected Area : E-House & T House

Protected Area	Agent Quantity	Number of Containers	Agent Application Density	Applicable Drawing(s)
E-House	6,000	2	109g / m ³	ASC1-Rev.5
T-House – Control Bay	400	2	109g / m ³	ASC4-Rev.5
T- House - Transformer	600	2	109g / m ³	ASC4-Rev.5

Remote system monitoring will be performed by : **AFP 3030 Site Network**
Date of Remote Monitoring Connection : To be Confirmed

Completed by:

Name: P Morris Signature: _____
 Company: Fire Safety Equipment Pty Ltd Date Completed: _____



FirePro System Commissioning

Risk Area: Moorebank Intermodal
CASC 80300 – E-House

Reference: ASC01

INSPECTION		
	Tasks	Completed
1.	Location of FirePro Aerosol Generators <ul style="list-style-type: none"> Ensure units are mounted in appropriate location(s). Are the brackets securely mounted. 	Yes Yes
2.	Cabling requirements <ul style="list-style-type: none"> Has fire rated and shielded cable used. Has cable been installed as per AS-3000. Separated from other electrical cables via conduit or cable tray. For High Voltage Environments - each FirePro unit is required to be connected to an earth circuit. Inspect cable fixings to ensure no damaged insulation. 	Yes Yes Yes Yes
3.	Fire Indicator Panel (FIP) <ul style="list-style-type: none"> Is the panel located in an appropriate location in accordance with Australian Standards. Is the power connection to the panel a direct, suitable and dedicated supply to the Panel. Is a separate battery backup installed. 	Yes Yes Yes
4.	Signage and Alarms <ul style="list-style-type: none"> Are appropriate signs / sounder strobes installed. 	Yes
COMMISSIONING		
1.	FIP Programming <ul style="list-style-type: none"> Programming of FIP meets client/site requirements. Check FIP for fault(s) e.g. correct connection of FirePro units, correct connection of detection circuit. 	Yes Yes
2.	Activation Testing <ul style="list-style-type: none"> ENSURE THE FIP IS SWITCHED TO SERVICE MODE. Activation testing to be performed in accordance with the procedures specific to the FIP installed. Ensure activation simulator lamps have activated Ensure Signs and Alarms have activated. Ensure shut down relays have activated. 	Yes Yes Yes Yes
3.	Fault Monitoring <ul style="list-style-type: none"> Disconnect cable from FirePro generator - fault should register on the FIP. Where multiple units are installed, this should done separately to test each unit. Remove detector head from base - fault should register on the FIP. 	Yes Yes
4.	Earth Testing <ul style="list-style-type: none"> Using a multimeter, test to ensure that all cables have insulation intact. Earth connection should indicate an open circuit 	Yes
5.	Detection Testing <ul style="list-style-type: none"> ENSURE THE FIP properly isolated from activating the Firepro system. Apply heat gun or other device to place detectors into alarm. Ensure Visual/Aural Alarms have activated. Where multiple units are installed, this should done separately to test each unit. 	Yes

Inspections all found to be compliant - Tests all completed.

Completed by :

Name: P Morris

Signature: 

Company: Fire Safety Equipment Pty Ltd

Date Completed: May 25, 2021



Reinventing
Fire Suppression

CERTIFICATE OF COMPLETION
& CONFORMITY

I/We (name of installer) **of** (company name) **hereby certify that we have completed a FirePro aerosol fire extinguishing installation/extension(s) in accordance with AS4487, as designed by** (company name).

Name of Client : **Kalmar Equipment Australia Pty Ltd.**

Address of Protected Area : Moorebank Intermodal – ASC02

Description of Protected Area : E-House

Protected Area	Agent Quantity	Number of Containers	Agent Application Density	Applicable Drawing(s)
E-House	6,000	2	109g / m ³	ASC1-Rev.5
T-House – Control Bay	400	2	109g / m ³	ASC4-Rev.5
T- House - Transformer	600	2	109g / m ³	ASC4-Rev.5

Remote system monitoring will be performed by : **AFP 3030 Site Network**

Date of Remote Monitoring Connection : To be Confirmed

Completed by:

Name: P Morris Signature: _____
 Company: Fire Safety Equipment Pty Ltd Date Completed: _____



FirePro System Commissioning

Risk Area: Moorebank Intermodal

Reference: ASC02

INSPECTION		
	Tasks	Completed
1.	Location of FirePro Aerosol Generators <ul style="list-style-type: none"> • Ensure units are mounted in appropriate location(s). • Are the brackets securely mounted. 	Yes Yes
2.	Cabling requirements <ul style="list-style-type: none"> • Has fire rated and shielded cable used. • Has cable been installed as per AS-3000. Separated from other electrical cables via conduit or cable tray. • For High Voltage Environments - each FirePro unit is required to be connected to an earth circuit. • Inspect cable fixings to ensure no damaged insulation. 	Yes Yes Yes Yes
3.	Fire Indicator Panel (FIP) <ul style="list-style-type: none"> • Is the panel located in an appropriate location in accordance with Australian Standards. • Is the power connection to the panel a direct, suitable and dedicated supply to the Panel. • Is a separate battery backup installed. 	Yes Yes Yes
4.	Signage and Alarms <ul style="list-style-type: none"> • Are appropriate signs / sounder strobes installed. 	Yes
COMMISSIONING		
1.	FIP Programming <ul style="list-style-type: none"> • Programming of FIP meets client/site requirements. • Check FIP for fault(s) e.g. correct connection of FirePro units, correct connection of detection circuit. 	Yes Yes
2.	Activation Testing <ul style="list-style-type: none"> • ENSURE THE FIP IS SWITCHED TO SERVICE MODE. • Activation testing to be performed in accordance with the procedures specific to the FIP installed. • Ensure activation simulator lamps have activated • Ensure Signs and Alarms have activated. • Ensure shut down relays have activated. 	Yes Yes Yes Yes
3.	Fault Monitoring <ul style="list-style-type: none"> • Disconnect cable from FirePro generator - fault should register on the FIP. Where multiple units are installed, this should done separately to test each unit. • Remove detector head from base - fault should register on the FIP. 	Yes Yes
4.	Earth Testing <ul style="list-style-type: none"> • Using a multimeter, test to ensure that all cables have insulation intact. Earth connection should indicate an open circuit 	Yes
5.	Detection Testing <ul style="list-style-type: none"> • ENSURE THE FIP properly isolated from activating the Firepro system. Apply heat gun or other device to place detectors into alarm. Ensure Visual/Aural Alarms have activated. Where multiple units are installed, this should done separately to test each unit. 	Yes

Inspections all found to be compliant - Tests all completed.

Completed by :

Name: P Morris

Signature:

Company: Fire Safety Equipment Pty Ltd

Date
Completed:

May 25, 2021



Reinventing
Fire Suppression

CERTIFICATE OF COMPLETION
& CONFORMITY

I/We (name of installer) **of** (company name) **hereby certify that we have completed a FirePro aerosol fire extinguishing installation/extension(s) in accordance with AS4487, as designed by** (company name).

Name of Client : **Kalmar Equipment Australia Pty Ltd.**

Address of Protected Area : Moorebank Intermodal – CASC03E

Description of Protected Area : E-House

Protected Area	Agent Quantity	Number of Containers	Agent Application Density	Applicable Drawing(s)
E-House	6,000	2	109g / m ³	ASC1-Rev.5
T-House – Control Bay	400	2	109g / m ³	ASC4-Rev.5
T- House - Transformer	600	2	109g / m ³	ASC4-Rev.5

Remote system monitoring will be performed by : **AFP 3030 Site Network**

Date of Remote Monitoring Connection : To be Confirmed

Completed by:

Name: P Morris Signature: _____

Company: Fire Safety Equipment Pty Ltd Date Completed: _____



FirePro System Commissioning

Risk Area: Moorebank Intermodal

Reference: ASC03

INSPECTION		
	Tasks	Completed
1.	Location of FirePro Aerosol Generators <ul style="list-style-type: none"> • Ensure units are mounted in appropriate location(s). • Are the brackets securely mounted. 	Yes Yes
2.	Cabling requirements <ul style="list-style-type: none"> • Has fire rated and shielded cable used. • Has cable been installed as per AS-3000. Separated from other electrical cables via conduit or cable tray. • For High Voltage Environments - each FirePro unit is required to be connected to an earth circuit. • Inspect cable fixings to ensure no damaged insulation. 	Yes Yes Yes Yes
3.	Fire Indicator Panel (FIP) <ul style="list-style-type: none"> • Is the panel located in an appropriate location in accordance with Australian Standards. • Is the power connection to the panel a direct, suitable and dedicated supply to the Panel. • Is a separate battery backup installed. 	Yes Yes Yes
4.	Signage and Alarms <ul style="list-style-type: none"> • Are appropriate signs / sounder strobes installed. 	Yes
COMMISSIONING		
1.	FIP Programming <ul style="list-style-type: none"> • Programming of FIP meets client/site requirements. • Check FIP for fault(s) e.g. correct connection of FirePro units, correct connection of detection circuit. 	Yes Yes
2.	Activation Testing <ul style="list-style-type: none"> • ENSURE THE FIP IS SWITCHED TO SERVICE MODE. • Activation testing to be performed in accordance with the procedures specific to the FIP installed. • Ensure activation simulator lamps have activated • Ensure Signs and Alarms have activated. • Ensure shut down relays have activated. 	Yes Yes Yes Yes
3.	Fault Monitoring <ul style="list-style-type: none"> • Disconnect cable from FirePro generator - fault should register on the FIP. Where multiple units are installed, this should done separately to test each unit. • Remove detector head from base - fault should register on the FIP. 	Yes Yes
4.	Earth Testing <ul style="list-style-type: none"> • Using a multimeter, test to ensure that all cables have insulation intact. Earth connection should indicate an open circuit 	Yes
5.	Detection Testing <ul style="list-style-type: none"> • ENSURE THE FIP properly isolated from activating the Firepro system. Apply heat gun or other device to place detectors into alarm. Ensure Visual/Aural Alarms have activated. Where multiple units are installed, this should done separately to test each unit. 	Yes

Inspections all found to be compliant - Tests all completed.

Completed by :

Name: P Morris

Signature:

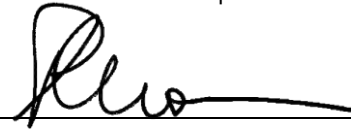

Company: Fire Safety Equipment Pty Ltd

Date Completed:

May 27, 2021



Reinventing
Fire Suppression

CERTIFICATE OF COMPLETION
& CONFORMITY

I/We (name of installer) **of** (company name) **hereby certify that we have completed a FirePro aerosol fire extinguishing installation/extension(s) in accordance with AS4487, as designed by** (company name).

Name of Client : **Kalmar Equipment Australia Pty Ltd.**

Address of Protected Area : Moorebank Intermodal – ASC04

Description of Protected Area : E-House

Protected Area	Agent Quantity	Number of Containers	Agent Application Density	Applicable Drawing(s)
E-House	6,000	2	109g / m ³	ASC1-Rev.5
T-House – Control Bay	400	2	109g / m ³	ASC4-Rev.5
T- House - Transformer	600	2	109g / m ³	ASC4-Rev.5

Remote system monitoring will be performed by : **AFP 3030 Site Network**

Date of Remote Monitoring Connection : To be Confirmed

Completed by:

Name: P Morris Signature: _____
 Company: Fire Safety Equipment Pty Ltd Date Completed: _____



FirePro System Commissioning

Risk Area: Moorebank Intermodal

Reference: ASC04

INSPECTION		
	Tasks	Completed
1.	Location of FirePro Aerosol Generators <ul style="list-style-type: none"> • Ensure units are mounted in appropriate location(s). • Are the brackets securely mounted. 	Yes Yes
2.	Cabling requirements <ul style="list-style-type: none"> • Has fire rated and shielded cable used. • Has cable been installed as per AS-3000. Separated from other electrical cables via conduit or cable tray. • For High Voltage Environments - each FirePro unit is required to be connected to an earth circuit. • Inspect cable fixings to ensure no damaged insulation. 	Yes Yes Yes Yes
3.	Fire Indicator Panel (FIP) <ul style="list-style-type: none"> • Is the panel located in an appropriate location in accordance with Australian Standards. • Is the power connection to the panel a direct, suitable and dedicated supply to the Panel. • Is a separate battery backup installed. 	Yes Yes Yes
4.	Signage and Alarms <ul style="list-style-type: none"> • Are appropriate signs / sounder strobes installed. 	Yes
COMMISSIONING		
1.	FIP Programming <ul style="list-style-type: none"> • Programming of FIP meets client/site requirements. • Check FIP for fault(s) e.g. correct connection of FirePro units, correct connection of detection circuit. 	Yes Yes
2.	Activation Testing <ul style="list-style-type: none"> • ENSURE THE FIP IS SWITCHED TO SERVICE MODE. • Activation testing to be performed in accordance with the procedures specific to the FIP installed. • Ensure activation simulator lamps have activated • Ensure Signs and Alarms have activated. • Ensure shut down relays have activated. 	Yes Yes Yes Yes
3.	Fault Monitoring <ul style="list-style-type: none"> • Disconnect cable from FirePro generator - fault should register on the FIP. Where multiple units are installed, this should done separately to test each unit. • Remove detector head from base - fault should register on the FIP. 	Yes Yes
4.	Earth Testing <ul style="list-style-type: none"> • Using a multimeter, test to ensure that all cables have insulation intact. Earth connection should indicate an open circuit 	Yes
5.	Detection Testing <ul style="list-style-type: none"> • ENSURE THE FIP properly isolated from activating the Firepro system. Apply heat gun or other device to place detectors into alarm. Ensure Visual/Aural Alarms have activated. Where multiple units are installed, this should done separately to test each unit. 	Yes

Inspections all found to be compliant - Tests all completed.

Completed by :

Name: P Morris

Signature: 

Company: Fire Safety Equipment Pty Ltd

Date Completed: May 27, 2021

7. Maintenance Requirements

7.1. Summary of Maintenance – AS1851 and AS 4487



Maintenance of Aerosol Systems

FirePro Maintenance requirements for Australian Standards

Maintenance requirements for FirePro Aerosol systems are under AS1851 – 2012 Section 7 Special Hazards. This standard covers all systems so additional references to AS4487-2013 aerosol systems are relevant. AS ISO 14520.1 specifies requirements and gives recommendations for the design, installation, testing, maintenance and safety of gaseous systems - It is not specifically relevant to Aerosol systems which are covered under AS4487-2013.

AS5062- 1851 also specifies a maintenance process. This process allows for a six monthly service, rather than the monthly service. The annual requirement includes a survey.

Australian Standard 1851-2012- SECTION 7 SPECIAL HAZARD SYSTEMS

- 7.1 GENERAL servicing (inspection, testing, preventive maintenance and survey) of gaseous, aerosol and open nozzle water mist special hazard fire suppression systems.
- 7.2.2 Prior to commencing service, take precautions to inform the responsible entity that service is to be carried out; where the system may be impaired, advise the nature and expected duration; advise the monitoring service provider where necessary; disable the system to ensure activities cannot cause discharge of system; set the detection and alarm system in test mode and ensure that ancillary facilities, systems and air-handling plant, where they are not to be tested, are isolated to avoid inadvertent operation. When any function is left impaired, disabled, it shall be recorded in the logbook and the owner or agent shall be notified
- 7.2.3 System isolation - Fixed aerosol fire extinguisher system actuation means shall be isolated by means of the maintenance isolate switch prior to undertaking the tests set out in Table 7.4.2. Where there is no maintenance isolate switch, aerosol fire extinguisher units shall be removed from the protected areas prior to testing.
- 7.2.4 Baseline data shall in accordance with Clause 1.8 and shall include a systems interface diagram.
- 7.2.5 Service records of activities and results detailed in Clause 7.4 shall be kept in accordance with Clause 1.16.

7.4.2 Monthly service of special hazards systems shall be in accordance with Table 7.4.2.

Item	Action required and pass/fail requirement	Pass/Fail Comments
1.1	Electrical detection and control systems. Perform service as per Section 6.	
1.2	Warning signs (printed signs and labels) CHECK all signs are visible and legible	
1.7	INSPECT the protected area to check to the baseline data. Any changes from the approved design (e.g. volume, fuel type, change of use).	
1.8	Aerosol units CHECK that all generators have not been discharged and are secure.	
1.9	Aerosol generator moisture seal CHECK that all moisture seals are secure.	

7.4.3 Six-monthly service of special hazards systems shall be carried out in accordance with Table 7.4.3.

Item	Action required and pass/fail requirement	Pass/Fail Comments
2.1	Monthly Service COMPLETE all monthly service activities as listed in Table 7.4.2	
2.2	Electrical detection and control systems Perform service as per Section 6.	
2.7	Manual release systems TEST operation of all manual release systems.	
2.9	CHECK that all discharge nozzles (including aerosol generators) are clear and unobstructed, correctly aimed and secured.	

7.4.4 Yearly service - service of special hazards systems shall be carried out in accordance with Table 7.4.4.

Item	Action required and pass/fail requirement	Pass/Fail Comments
3.1	Monthly and six monthly service COMPLETE as per Tables 7.4.2 and 7.4.3.	
3.2	Electrical detection and control systems service in accordance with Section 6.	
3.5	Detection system (mechanical) CHECK operation and lubricate as necessary	
3.10	Dampers CLEAN dampers that have been subjected to the deposit of contaminants	
3.11	CHECK for any condition that could cause inadvertent discharge of the system.	
3.12	Type of hazard VERIFY fuel class and type match baseline data.	

- 3.13 Enclosure volume (total flooding systems) VERIFY matches the baseline data.
- 3.14 Design concentration or application density VERIFY matches baseline data.
- 3.15 Dimensions of protected objects (local systems) VERIFY matches the baseline data.
- 3.18 Adjacent areas INSPECT all areas adjacent to the protected area to ensure that migration of extinguishing agent does not create a hazard to personnel
- 3.19 Ventilation dampers Test operation of automatically operated ventilation dampers.
- 3.20 System interfaces with HVAC systems, see Clause 1.12 and Section 10
- 3.21 Post-discharge ventilation TEST the operation of the post-discharge system.
- 3.23 System interface test (see Clause 1.12.2)
 - (a) CONDUCT functional system test with other interfaced fire systems (e.g. HVAC, EWS).
 - (b) VERIFY functions in accordance with the building's systems interface diagram.
- 3.24 Aerosol generators REPLACE any generator that will exceed its listed service life prior to the next scheduled routine service.

7.4.5 Ten-yearly service - service of special hazards systems shall be carried out in accordance with Table 7.4.5.

Item	Action required and pass/fail requirement	Pass/Fail Comments
4.1	Monthly, Six monthly and Yearly service COMPLETE all activities required	

FAN INTEGRITY TESTING, STRUCTURAL INTEGRITY AND VENT RELIEF

Summary, the properties of aerosols being a particle have different characteristics than gaseous agents. There is no requirement for annual fan integrity test. Vent relief is not required due to the discharge pressure of FirePro aerosols being 6-8kpa; this creates no additional pressure within the risk.

AS4487-2013 - EXTRACTS

AS4487 - 7.6 (Para. 2) "Due to the specific characteristics of the extinction process of condensed aerosols that primarily produce particulates, no method is known to evaluate the hold time in real installations, other than real discharge which is not practical. For this reason, a specific test is required for each aerosol formulation to determine the maximum leakage area to volume ratio that provides for the minimum hold time declared by the manufacturer. The approach for determining hold time is detailed in Appendix E, Paragraph E7.

AS4487 - E7 TEST OF THE DETERMINATION OF THE MAXIMUM LEAKAGE AREA TO VOLUME RATIO - Principle - An aerosol extinguishing formulation shall be able to keep extinguishing conditions for the hold time when tested in accordance with this test method under the maximum design limitations and most severe installation instructions. The test is based on the ability of the extinguishing unit to prevent ignition of heptane cans distributed through the enclosure.

The board of experts at the ISO TC21 SC8 (Gaseous Media and Fire Fighting Systems Using Gas) and the working group who developed ISO 15779 Standard for aerosol systems, recognized the impossibility to measure accurately the resulting aerosol agent density due to the aerosol agent specific characteristics (micro solid particles carried by a gas), thus the impossibility to derive a formula of leakage compensation.

The door fan test applied for gas agents, cannot be used for Aerosol agents', as density is not measurable.

Furthermore, the extinguishing application density is applied with an additional safety factor to ensures that the leakage area indicated will not affect the extinguishing performance.

AS4487 - 7.2.1 - The designer/installer shall provide reliable calculations for venting requirements for each system if applicable.

A calculation method or formula to estimate a minimum vent area shall be provided by the system manufacturer. The FirePro generators discharge at approx. 6-8kpa. Unlike high-pressure gases, the discharge creates no additional pressure within the risk. So even with additional design application density vent relief will not be required as determined by the manufacturer under UL 2775.

Australian Standard 5062-2016 Section 11 - Fire Protection Systems Maintenance

11.1 A service program shall be carried out in accordance with this Section. As a minimum, the requirements set out in the Tables shall be followed. Any additional service procedures detailed in the fire protection system manufacturer's listed manual shall also be followed.

11.3.1 Records shall be retained by the owner and shall include the following details:

- (a) Service activities.
- (b) Defects.
- (c) Rectifications and by whom.
- (d) Date conducted.
- (e) Baseline data.

11.3.2 A service tag or label should be provided for each fire protection system to record the last level of inspection, test and survey performed.

The level of service carried out shall be stamped, or indelibly marked on the tag or label, with a figure representing the routine as follows:

- 1 Six-monthly
- 2 Yearly
- 4 Five-yearly
- 5 Recharge after use

AS 5062 MAINTENANCE RECORD														
YEAR	JAN	FEB	MAR	APR	MAY	JUNE	JULY	AUG	SEPT	OCT	NOV	DEC		
01													PRESSURE TEST	93
02														94
03														95
04														96
05														97
06														98
07														99
08														00

11.5 Only the extinguishing agent detailed in the system listing shall be used to recharge the system.

11.6.1 Pre-engineered systems service shall be in accordance with manufacturer's recommendations and shall be no less than specified in the Tables. For engineered systems, service shall be carried out in accordance with the requirements of AS 1851, with the exception that the frequency of routines shall be varied where necessary to suit the conditions under which the system has been installed.

11.6.2 Critical defects shall be rectified before the equipment is operated and shall be reported to the responsible entity and confirmed in writing within 24 h. Non-critical defects shall be rectified as soon as practicable and reported to the responsible entity.

11.6.3 A design survey together with the inspection, test and maintenance regime demonstrates that the systems or equipment are functional and capable of performing to original design. The survey shall include a check against the baseline data, and consider changes in use or operating environment, or other factors that could affect the performance of the fire system.

11.6.4 A system condition report shall be completed on an annual basis and shall be submitted to the equipment owner within one month of the scheduled annual maintenance being performed. The system condition report shall contain the results of all procedures included in Tables 11.3, 11.4 and 11.5.

11.7 Routine service of shall be carried out in accordance with Tables 11.2 to 11.5

TABLE 11.1 - SERVICE FREQUENCY TOLERANCES

Frequency	Tolerance
Six-monthly	±1 month
Yearly	±2 months
Five-yearly	±3 months

TABLE 11.2 - DAILY ROUTINE SERVICE SCHEDULE *

Item	Action required and pass/fail requirement	Pass/Fail Comments
------	---	--------------------

Maintenance of Aerosol Systems

- 1.1 Check all containers are viable and properly mounted.
- 1.2 Manual actuators Check that all release anti-tamper seals/pull pins are in place and secure. Check that all actuators are secure, clean, undamaged and accessible..
- 1.3 System control and indicating equipment. Check that all indicators show normal condition. Check that all panels are secure, clean, undamaged and accessible

* The daily inspection is normally carried out by the operator prior to equipment start-up, shift-change or operator change and may be recorded by a single entry.

TABLE 11.3 - SIX-MONTHLY ROUTINE SERVICE SCHEDULE

Item	Action required and pass/fail requirement	Pass/Fail Comments
2.1	Complete all daily routine service activities listed in Table 11.2	
2.2	Check aerosol canisters are properly located and aimed. Check electrical cables are properly secured and undamaged.	
2.3	System control and indicating equipment. Check that all indicators show normal condition. Check that all panels are secure, clean, undamaged and accessible	
2.4	Electric detection system - Check, wiring, connection and supports are in intact, not damaged and detectors are in position.	
2.5	Check manual release, system instruction labels are in place, and legible.	
2.7	Manual actuators) Physically check that all actuators are secure, clean, undamaged and accessible. Test operation.	
2.8	System control equipment. Test all indicators and audible alarms. Test battery capacity.	

TABLE 11.4 - YEARLY ROUTINE SERVICE SCHEDULE

Item	Action required and pass/fail requirement	Pass/Fail Comments
3.1	Complete all six monthly service activities listed in Table 11.3	
3.3	Aerosol Generators Replace any generator that will exceed its generators listed service life prior to the next scheduled routine service	
3.5	Electric actuation system - function test all actuation check all wiring for earths, check wiring, connections and supports are secure circuits	
3.6	Electric detection system - function test all detectors, check all wiring for earths, check wiring, connections and supports are secure	
3.8	System Test all fire suppression system activated interface and equipment shutdowns and record delay time shutdown	
3.17	Detector coverage Check for the presence of unprotected hazard areas, particularly where a source of fuel and heat exists	
3.18	Operational conditions. Check that the detector response and agent discharge or retention will not be adversely affected by such things as enclosure openings, ventilation airflows or high temperature areas.	
3.19	Environmental conditions Check that the fire system and its components are suitable for the environmental conditions in which the machine is operating, e.g. that components are suitable for underground mining, and road gradient and slopes are within container orientation limits.	
3.20	Survey Complete review of system to confirm it is in accordance with the approved design and no changes have been made which would impair performance	

TABLE 11.5 - FIVE YEARLY ROUTINE SERVICE SCHEDULE

Item	Action required and pass/fail requirement	Pass/Fail Comments
4.1	Complete all yearly service activities listed in Table 11.4	

7.2. Extract from AS1851 – Maint. of Fire Detection and Alarm Systems

Maintenance requirements for the fire detection and alarm system serving the Firepro condensed aerosol fire suppression system for the Transformer Room shall be carried out in accordance with AS 1851-2012 – Section 6.

AS 1851-2012 – SECTION 6

This Section sets out the requirements for the routine servicing (inspection, testing, preventive maintenance and survey) of fire detection and alarm systems.

The requirements for routine service of emergency warning systems and emergency intercom systems shall be in accordance with Clauses 6.4.3 and 6.4.4, respectively.

This Section shall be read in conjunction with Section 1.

6.1 ROUTINE SERVICE PROCESS AND PROCEDURES

6.1.1 Routine service

All fire detection and alarm systems shall be inspected and tested on a monthly basis. Further testing, preventive maintenance and survey shall be carried out at the periodic intervals specified in Clauses 6.3 and 6.4.

6.1.2 Precautions

Prior to commencing any testing or preventive maintenance, the following precautions shall be taken:

- (a) Take all reasonable precautions as to not adversely affect the normal operation of any system except for those systems to be maintained or to adversely affect occupants of the building, or to cause any situation that will cause an unwanted alarm.
- (b) Inform the responsible entity or nominated person that routine service is to be carried out, which may adversely affect the occupants or operations of the building.
- (c) Inform the responsible entity or nominated person to the extent of the impairment during the routine service so that alternative safety arrangements can be implemented.
- (d) Notify the monitoring service provider where testing or service may cause signals to be transmitted.

NOTE: The notification may be by configuring the alarm signalling equipment to test mode and confirmation that the system has been restored to 'normal' by the alarm signalling equipment returning to 'normal'.

On completion of any testing or service, return all controls to their prior state. When any function is left impaired, disabled or is not restored to 'normal', it shall be recorded in the system logbook and the owner or agent shall be notified.

6.1.3 Survey

Detection systems shall be surveyed in accordance with the survey requirements specified in Clauses 6.4.1 to 6.4.5.

C6.2.3 A survey is typically conducted visually from floor level and is intended to identify changes to the detection system or the building and its occupancy which could impair the performance of the detection system.

6.1.4 Baseline data

Baseline data shall be in accordance with Clause 1.8 and shall include a systems interface diagram Clause 1.12

6.1.5 Service records

Records of activities and results detailed in Clause 6.4 shall be kept in accordance with Clause 1.16.

6.1.6 Reports

Critical defect and yearly condition reports shall be prepared and distributed in accordance with Clause 1.17.2.

6.2 FREQUENCY

The frequency of routine servicing of detection systems shall be in accordance with the following and Clause 6.4.

- (a) Monthly.
- (b) Six-monthly.
- (c) Yearly.
- (d) Five-yearly.

6.3 ROUTINE SERVICE SCHEDULES

6.3.1 Fire detection and alarm system, special hazard systems and smoke hazard management

Routine service of fire detection and alarm systems, special hazards systems and smoke hazard management, shall be carried out in accordance with Tables 6.4.1.2 to 6.4.1.5.

TABLE 6.4.1.2 MONTHLY ROUTINE SERVICE SCHEDULE FIRE DETECTION AND ALARM SYSTEM, SPECIAL HAZARD SYSTEMS AND SMOKE HAZARD MANAGEMENT SYSTEMS

Item No.	Item	Action required and pass/fail requirement	Records		
			Result	Pass/Fail	Comments
1.1	External alarm	INSPECT the external alarm (bell or strobe light) to ensure it clearly indicates the designated building entry point. Inspect to ensure the external alarm label is legible with the word 'FIRE' in characters not less than 25 mm in height.			
1.2	Control and indicating equipment (CIE)	INSPECT the following as applicable: Fire indicator panel (FIP), sub-indicator panel (SIP), repeater panel, fire brigade panel (FBP), mimic panel, fire fan control panel (FFCP) and— (a) ensure that they are clearly visible, readily accessible and free from dust and contaminants; and (b) where a panel is obscured by a door, check that the door is correctly labelled. Where manual call points use replaceable frangible elements, ENSURE that at least one replacement element and tool are available for replacing the element where required.			
1.3	Battery enclosure	Where vented batteries are used, INSPECT the battery enclosure for evidence of corrosion.			

Item No.	Item	Action required and pass/fail requirement	Records		
			Result	Pass/Fail	Comments
1.4	Fire alarm	SIMULATE an alarm condition and confirm that all required common or general visual and audible indications operate and the external alarm is activated. Where the system is monitored ensure the alarm has activated the alarm signalling equipment. Where CIE is a sub-indicator panel, confirm that the alarm condition is indicated at the FIP.			
1.5	Occupant warning system	SIMULATE an alarm and confirm the alarm initiates the occupant warning system including any visual warning devices (VWD).			
1.6	Isolate/Disable	INITIATE an isolate/disable condition at the fire indicator panel and confirm that all required common or general visual and audible indications operate. Where the system is monitored, ensure the isolate is received by the monitoring service provider alarm signalling equipment. Where the panel is an SIP, confirm that the isolate/disable condition is indicated at the FIP as either a fault or isolate/disable.			
1.7	Filament visual indicators	TEST the operation of each filament type visual indicators.			
1.8	Zone block plan	INSPECT zone block plans to ensure that they are securely mounted and legible and supplementary zone drawings, where required, are available and legible.			
1.9	Baseline data documentation	CHECK that baseline data is available and legible.			

TABLE 6.4.1.3 SIX-MONTHLY ROUTINE SERVICE SCHEDULE FIRE DETECTION, ALARMS AND CONTROLS FOR SPECIAL HAZARD SYSTEMS

Item No.	Item	Action required and pass/fail requirement	Records		
			Result	Pass/Fail	Comments
2.1	Monthly service	Complete all monthly service activities, as listed in Table 6.4.1.2.			
2.2	Local control station (LCS)	(a) Ensure that they are clearly visible readily accessible and free from dust and contaminants.			
		(b) Check that the door is correctly labelled.			
2.3	Visual warning devices	INSPECT all visual warning devices, including:			
		• DO NOT ENTER			
		• EVACUATE			
		• FIRE ALARM			
		• SYSTEM INOPERATIVE			
		for any condition or damage that is likely to adversely affect their function.			
2.4	Local control station (LCS) discharge inhibit switch	TEST the operation of each inhibit or auto/manual switch and confirm that:			
		(a) It prevents the automatic discharge of suppression system.			
		(b) Stops and resets the normal system discharge sequence.			

Item No.	Item	Action required and pass/fail requirement	Records		
			Result	Pass/Fail	Comments
		(c) Causes the illumination of a visual indicator at the LCS and the system FIP.			
		(d) Causes an audible indication.			
		(e) Does not override the operation of the manual discharge switch.			
2.5	Local control station (LCS) manual initiate switch	TEST the operation of the manual initiate switch and confirm normal system discharge sequence, including fire and evacuation alarms, time delays equipment shutdowns, and that it overrides the LCS discharge inhibit switch.			
2.6	System inoperative visual warning device (VWD)	CONFIRM the system inoperative VWD operates for:			
		(a) Operation of a service switch (discharge initiating circuit electrical isolation).			
		(b) Fault in the discharge actuator circuit.			
		(d) Operation of a manual inhibit switch (where fitted).			
		(e) Isolation or fault in any part of the fire detection or control system that prevents the automatic or electrical manual discharge of the suppression system.			
2.7	System operation and logic	TEST the system logic (e.g. dual detector operation or dependency on more than one alarm) and confirm that the operation of—			
		• VWDs			
		• audible alarms			
		• equipment fire mode signal/output			
		• HVAC fire mode signal/output			
		• system discharge actuators			
		• damper release and			
		• ancillary controls			
	is in accordance with the approved design.				
2.8	Actuator circuit faults	TEST each supervised actuator circuit to ensure a fault is registered at the FIP.			
2.9	Actuator	TEST the function of each actuator and ensure that each actuator operates correctly. Ensure that each actuator has been mechanically isolated or temporarily removed from the suppressant supply to prevent unintended discharge. For non-resettable actuators (e.g. pyrotechnic types) substitute the actuator with a load of equivalent value and CONFIRM the operating current is in accordance with baseline data.			

NOTE: Take precautions to prevent the discharge of the system during these tests.

TABLE 6.4.1.4 YEARLY ROUTINE SERVICE SCHEDULE FIRE DETECTION AND ALARM SYSTEM, SPECIAL HAZARD SYSTEMS AND SMOKE HAZARD SYSTEMS

Item No.	Item	Action required and pass/fail requirement	Records		
			Result	Pass/Fail	Comments
3.1	Monthly and six-monthly service	COMPLETE all monthly and six-monthly service activities, as listed in Table 6.4.1.2 and 6.4.1.3.			
3.2	Manual call points	CHECK all manual call points are free of conditions likely to adversely affect their function.			
3.3	Manual call points	TEST the operation of each manual call point.			
3.4	Other warning devices	Where other warning devices are used as the Alarm-indicating devices, INSPECT all devices to ensure that they are in place.			
3.5	Panel switches and keypads	TEST the operation of each control.			
3.6	Visual indicators	TEST the operation of each visual indicator and alphanumeric displays.			
3.7	Battery	MEASURE system quiescent and maximum alarm currents in accordance with Appendix F. Calculate the required battery capacity and CHECK the nominal capacity of the installed batteries is not less than the calculated capacity. Verify that the measured currents are the same as recorded in the baseline data.	QuiescentIq Required capacityAh Installed capacityAh		
3.8	Fire Detectors	TEST detectors as specified in Appendix G and confirm correct alarm zone indication. Where the detectors are used as part of special hazards systems 100% of the detectors shall be functionally tested yearly.			
3.9	Audibility	TEST the occupant warning system and check the signals are distinctly audible in all areas of the building. NOTE: In order to reduce the disturbance to occupants an acceptable means of conducting this test is to provide an audio signal other than the warning signal at a reduced sound pressure level. Where the FIP is connected to a sound systems and intercom systems for emergency purposes (AS 1670.4) or EWIS (AS 2220.2) test in accordance with Table 6.4.3.2.			
3.10	Occupant warning system sound pressure level	MEASURE and record the sound pressure level from at least one reference point for each amplifier used and ensure at each reference point the measured value is consistent with the baseline sound pressure level at each reference point (see AS 1670.1).	Location of reference points..... Baseline SPLdBA Measured test SPLdBA		

Item No.	Item	Action required and pass/fail requirement	Records		
			Result	Pass/Fail	Comments
3.13	Batteries condition	When the battery has not been replaced in the previous two years, verify the battery condition by carrying out a battery discharge test in accordance with Appendix F.	Date last replaced or; Test load current.....A Final test voltage..... V		
3.15	Service life	Inspect detectors, equipment or other items having a defined service life and report where the service life is exceeded or will be exceeded before the next scheduled service.			
3.16	Baseline data	CONFIRM the baseline data is accurate.			
3.17	Protected areas survey	SURVEY all areas of the building from floor level and check— (a) that the fire detection and alarm system has not been altered from the approved design, damaged or compromised; (b) detection device and remote indicators are appropriate for the current use; (c) for any condition that may cause a nuisance alarm or the unintentional operation of a suppression system; (d) all exposed cabling, conduits, junction boxes and the like for any condition that may impact on the performance of the system and is labelled in accordance with approved design; and (e) all CIE to ensure all components are appropriately mounted and secure.			
3.18	Interfaced system initiation	Simulate alarm(s) to verify that each interface transmission path initiates the corresponding interfaced system(s) in accordance with the approved design.			

SPECIAL HAZARD SYSTEMS—ADDITIONAL ACTIVITIES

CAUTION: TAKE PRECAUTIONS TO PREVENT THE DISCHARGE OF THE SYSTEM DURING THESE TESTS

3.28	Status monitoring	TEST the each suppression system status monitored function (e.g. container level, pressure switches, pump controllers, isolation valves) and CHECK each monitored function indicates at the suppression system control panel.			
3.29	Suppression system directional valves	SIMULATE the system operation and confirm that each electrical directional valve operates according to the approved design.			
3.30	Discharge time delay	TEST and RECORD the system discharge Sequence and confirm the time delay period is in accordance with the approved design.			
3.31	Agent release indication	TEST the agent release detection device (e.g. pressure switch) and confirm the operation of the agent release is indicated at the FIP.			

TABLE 6.4.1.5 FIVE-YEARLY ROUTINE SERVICE SCHEDULE FIRE DETECTION AND ALARM SYSTEMS

Item No.	Item	Action required and pass/fail requirement	Records		
			Result	Pass/Fail	Comments
4.1	Monthly, six-monthly and yearly service	Complete all monthly, six-monthly and yearly service activities, as listed in Tables 6.4.1.2, 6.4.1.3 and 6.4.1.4.			
4.2	Supervised circuits	TEST each input and output supervised circuit for any condition that prevents the transmission of the required signal and ensure a fault is registered at the FIP.			
4.3	Fault	SIMULATE a circuit fault condition at the FIP and confirm that all required common or general visual and audible indications operate. Where such faults are monitored, ensure the fault has activated the alarm signalling equipment. Where the panel is an SIP confirm that the fault condition is indicated at the FIP.			
4.4	Addressable short circuit isolators	Apply short circuits as required to verify that no more than 40 devices are disabled by a single short circuit.			
4.5	Power supply supervision	Where the system is monitored, REDUCE the CIE operating voltage to trigger a power supply supervision fault and CONFIRM that it is received by the monitoring service provider. Where the panel is an SIP or a distributed power supply, confirm that the power supply supervision fault condition is indicated at least as a fault at the FIP.			
4.6	Collective detection circuits	For each collective fire detection circuit, REMOVE the last detector or device on the circuit and confirm that a fault signal is registered at the CIE.			
4.7	Interface and control test	CONDUCT a functional test with each system interface in accordance with the building's systems interface diagram and CHECK that each interfaced system responds to the signal in accordance with the approved design. See Appendix D.			
4.9	Monitoring connection	Where the system is monitored, TEST that the loss of each of the monitoring links is indicated at the monitored site.			



1. Maintenance General

Where FirePro systems have been installed in accordance with AS4487: Condensed Aerosol Fire Extinguishing Systems, periodic maintenance must be performed as per the requirements of AS1851: Routine Service of Fire Protection Systems and Equipment.

AS1851 Section 7.4 sets out the requirements for routine servicing in a monthly, six monthly and yearly schedule. Servicing should only be performed by suitably qualified personnel.



2. Testing

Must be performed as per AS1851, Sections 6.4.1 and 7.4.2 by accredited service technicians. A logbook must be kept, recording all the relevant information from the installation and servicing

Monthly Servicing should be performed as follows, with any system repairs completed as necessary:

- Servicing should not be performed when the fire control panel is in an alarm/fault condition.
- No personnel should be in the risk area until the fire system is fully isolated.
- Where shutdown relays have been utilised, all personnel should be made aware equipment will not be operable until testing is completed. Shutdown Isolation Module (P/N 98510) may be used to bypass shutdown relays and allow for normal operation of connected equipment during testing.

2.1. Visual Inspection

- 2.1.1. CIE and installed components should be accessible and free from debris, rust, electrical faults, or other damage.
- 2.1.2. Inspect CIE to ensure normal functioning. When the Sigma XT/Local Control Station is functioning normally the only indicators illuminated should be "Power" (green) on the Alarm Module and the Extinguishing Module.
- 2.1.3. All anti-tamper seals and travel pins should be in place and secure.
- 2.1.4. CIE, warning signs and strobes should be clearly visible and must indicate the designated egress points for the risk area.
- 2.1.5. Ensure that all FirePro Aerosol Generators have not been discharged and seals are intact.
- 2.1.6. Inspect the risk area to ensure that the risk has not changed from the approved design.
- 2.1.7. Review base data for any changes in environment or equipment installed.
- 2.1.8. Test operation of all CIE LED indicators by pressing the "Lamp Test" button on the Alarm Module

2.2. Isolation of System

Isolate Function: it is important to isolate the activation of the suppression system before any testing of the system is attempted. To isolate:

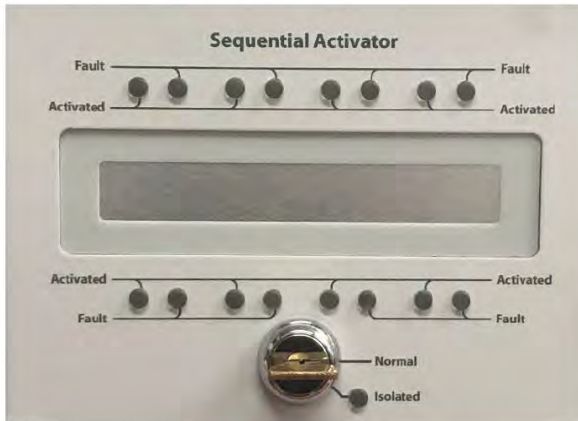

SYSTEM – NORMAL



SYSTEM ISOLATED

- 2.2.1. The fire suppression system activation circuit **must** remain isolated until all other testing is completed.
- 2.2.2. Unlock and open the display window for the Sigma XT. The centre lock opens the display window, allowing for operation of the controls.
- 2.2.3. Insert the 003 key into the isolate switch and turn until isolate LED is lit. The FirePro units are now isolated from activation.
- 2.2.4. This will initiate a fault and operate all installed “System Inoperative” warning signs.
- 2.2.5. Inspect all installed “System Inoperative” Warning Signs to ensure operation.
- 2.2.6. Where the Sigma XT is being remotely monitored or used as a Sub-Indicator Panel, ensure that the system isolation has been reported to monitoring equipment.



2.3. Isolation of Shutdown outputs

Where fitted, a shutdown isolation switch can be operated. This switch is operated by a “003” key, and when the switch is activated, any shutdown function which have been connected through this switch will be isolated.

- 2.3.1. Place the 003 key in the “Normal-Isolate” key switch located on the Shutdown Isolate Switch, which is in a separate enclosure adjacent to the FIP and turn from “Normal” to “Isolate Shutdown”.

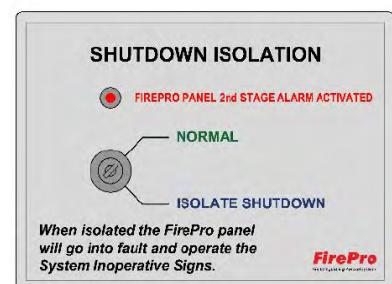

- 2.3.2. This will initiate a fault and operate all installed “System Inoperative” warning signs.

- 2.3.3. The shutdown functions which are connected through the Shutdown Isolation Switch will continue as normal and will not be affected by the system testing regime.
- 2.3.4. The switch must be returned to the “Normal” position once testing is complete.

2.4. Alarm Function

The system must be placed into alarm and simple function tests observed to ensure that the system is capable of performing as designed

- 2.4.1. Simulate a single zone alarm by appropriately testing one of the installed detectors or manual call points. Testing should be performed on a different detector for each monthly service, so that over a period each device on the detection circuits has been individually tested.
- 2.4.2. Smoke Detectors can be tested using “Canned Smoke”. A spray of canned smoke should be applied to a detector and this should place the detector into alarm.
- 2.4.3. Thermal or Heat detectors can be tested with a Thermal Testing device. Applying heat to the detector should place the detector into alarm.
- 2.4.4. Flame detectors require a special simulation device which can be aimed at the flame detector to create an alarm condition.
- 2.4.5. This will operate all installed “Fire Alarm”, “Evacuate Area” and “Do Not Enter” warning signs, sirens and strobes.



- 2.4.6. The FirePro panel incorporates a mimic panel located in the Extinguishant Module of the FIP. This mimic panel will show by Red LEDs as each of the FirePro units are activated, without actually activating the units.



- 2.4.7. Inspect all installed Warning Signs, sirens and strobes to ensure operation.
- 2.4.8. Ensure operation of all installed shutdown relays and connected equipment.

- 2.4.9. Where the Sigma XT is being remotely monitored or used as a Sub-Indicator Panel, ensure that the alarm condition has been reported to monitoring equipment.

2.5. **Reset**

The Fire Indicator Panel must be reset once the testing is complete, this will allow the system to go back to operational status.

- 2.5.1. Unlock and open the centre display window. The centre lock opens the display window, allowing for operation of the controls.
- 2.5.2. Place the 003 key in the "Enable Control" key switch located on the Alarm Module and turn to enable "ACCESS LEVEL 2".
- 2.5.3. Press the "Reset" Button on the Alarm Module to reset the Sigma XT to normal condition.
- 2.5.4. Turn back the 003 key in the "Enable Control" key switch to exit "ACCESS LEVEL 2" and allow normal operation of the CIE.
- 2.5.5. CIE should no longer be in an alarm condition. The fire suppression system must remain isolated until CIE is no longer in an alarm condition.
- 2.5.6. Place the 003 key in the "Normal-Isolate" key switch located on the Extinguishing Module and turn from "Isolate" to "Normal".
- 2.5.7. Place the 003 key in the "Shutdown Isolate Switch" key switch normally located adjacent to the FIP in a separate enclosure and turn from "Isolate Shutdowns" to "Normal".
- 2.5.8. CIE should no longer be in a fault condition.
- 2.5.9. Close and lock the central display window. System is now operational.

2.6. **Logbook**

Logbook must be updated to record the outcome of servicing and any changes or repairs to the fire system.

2.7. **Review**

Following servicing, the fire suppression system should be reviewed for fitness of purpose.

Fire Suppression System General Arrangement - E-House

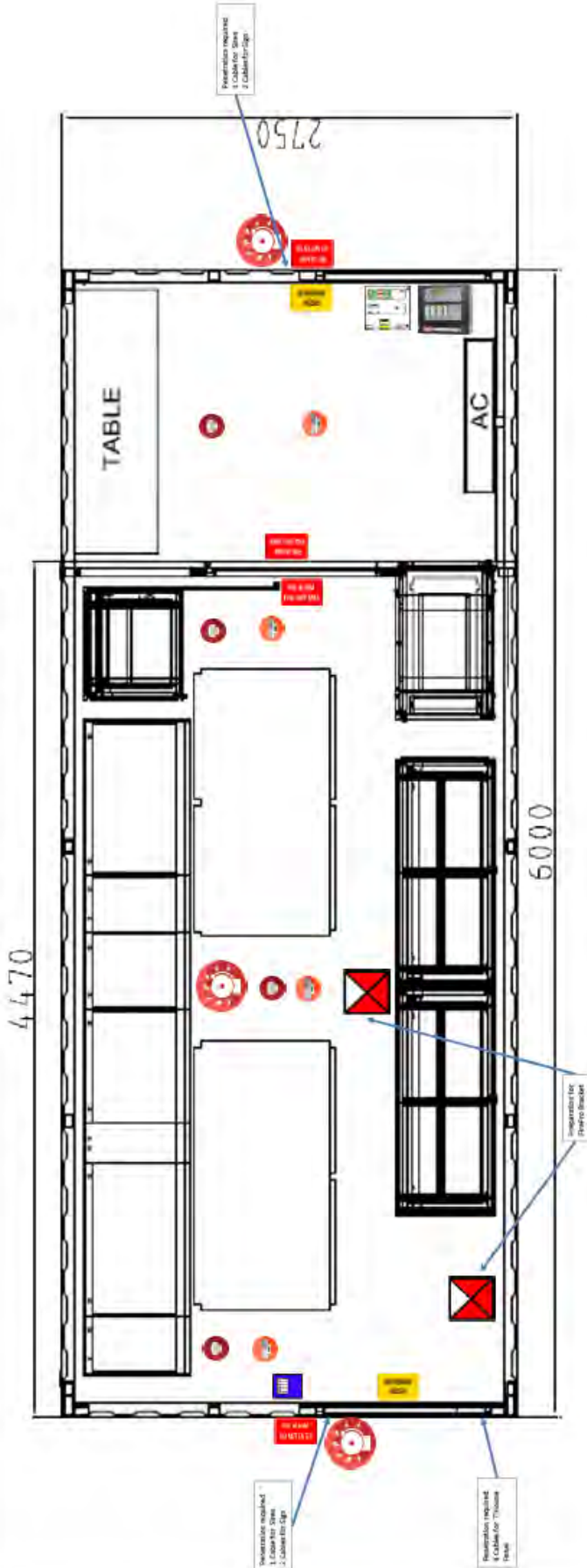

NOTES:

- 1 All cable to be (Except for incoming 230VAC power supply)
 - + Fire Rated to 120m
 - + Shielded
 - + Outer insulation RED
 - + Conductors to be min 0.75mm Stranded
- 2 Locations of devices are general only
- 3 Local Control Panel for T-House via FPC2
- 4 Linear Heat Detection Cable used in T-House
- 5 FPC-2 Reports Back to Sigma XT panel for Fire and Faults
- 6 Sigma XT Panel reports to AFP-3030 Panel
- 7 AFP-3030 takes Fire/Fault signal from Sigma XT, all circuits supervised.
- 8 Power to FIP AFP-3030 and Sigma XT 230AC
- 9 ACTIVATION TO BE BASED ON both Thermal and Smoke Detectors in Alarm
- 10 Shutdown to be based on EITHER Thermal or Smoke Detectors in Alarm
- 11 On Alarm, Estop to be activated and all AC to be Shutdown

SYMBOL	QTY	DESCRIPTION
	2	FirePro Aerosol Generator - 3000G
	3	Flasher Siren / Strobe
	4	Hochiki 60DC RoR Thermal Detector
	4	Hochiki Photo Electric Smoke Detector
	1	Sigma XT - 2 Zone Conventional FIP
	1	AFP 3030 Fire Indicator Panel
#REF! Local Control Station		
	2	Sign - Fire Alarm - Evacuate Area
	2	Sign - Fire Alarm - Do Not Enter - WIP
	2	Sign - System Inoperative

Drawn By		Title		Drawing No
PM		Cargotec Morebank		ASC1
Date		ASC E House Fire Suppression System		Rev.5
17-03-10		FIRE SAFETY EQUIPMENT PVT LTD		

Fire Suppression System - E-House - Signs & Sirens Wiring Diagram

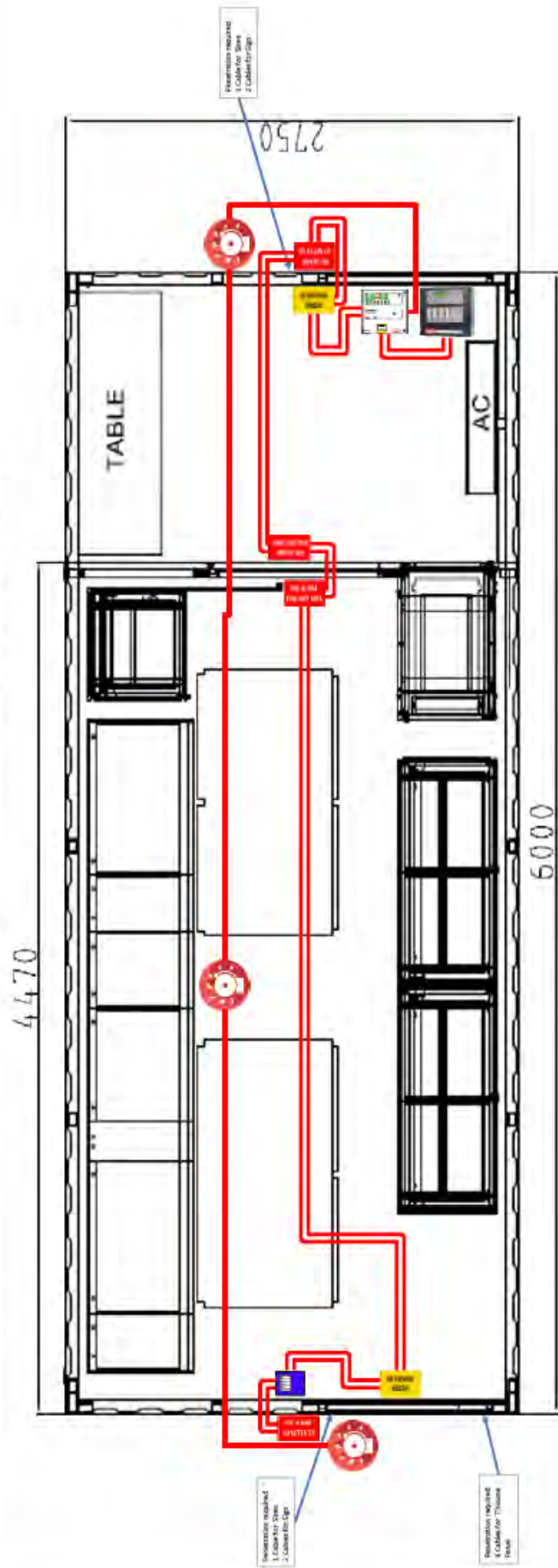

NOTES:

- 1 All cable to be (Except for incoming 230VAC power supply)
 - ★ Fire Rated to 120m
 - ★ Shielded
 - ★ Outer insulation RED
 - ★ Conductors to be min 0.75mm Stranded
- 2 Locations of devices are general only
- 3 Local Control Panel for T-House via FPC2
- 4 Linear Heat Detection Cable used in T-House
- 5 FPC-2 Reports Back to Sigma XT panel for Fire and Faults
- 6 Sigma XT Panel reports to AFP-3030 Panel
- 7 AFP-3030 takes Fire/Fault signal from Sigma XT, all circuits supervised.
- 8 Power to FIP AFP-3030 and Sigma XT 230AC
- 9 ACTIVATION TO BE BASED ON both Thermal and Smoke Detectors in Alarm
- 10 Shutdown to be based on EITHER Thermal or Smoke Detectors in Alarm
- 11 On Alarm, Estop to be activated and all AC to be Shutdown

SYMBOL	QTY	DESCRIPTION
	2	FirePro Aerosol Generator - 2000G
	3	Flashini Siren / Strobe
	4	Hochiki 60SC RoR Thermal Detector
	4	Hochiki Photo Electric Smoke Detector
	1	Sigma XT - 2 Zone Conventional FIP
	1	AFP 3030 Fire Indicator Panel
#REF: Local Control Station		
	2	Sign - Fire Alarm - Evacuate Area
	2	Sign - Fire Alarm - Do Not Enter - WP
	2	Sign - System Inoperative

Drawn By	FM	Date	17-02-10
Title			
Cargotec Morebank		Drawing No	
ASC E House Fire Suppression System		ASCZ Rev.5	

Fire Suppression System General Arrangement - E-House

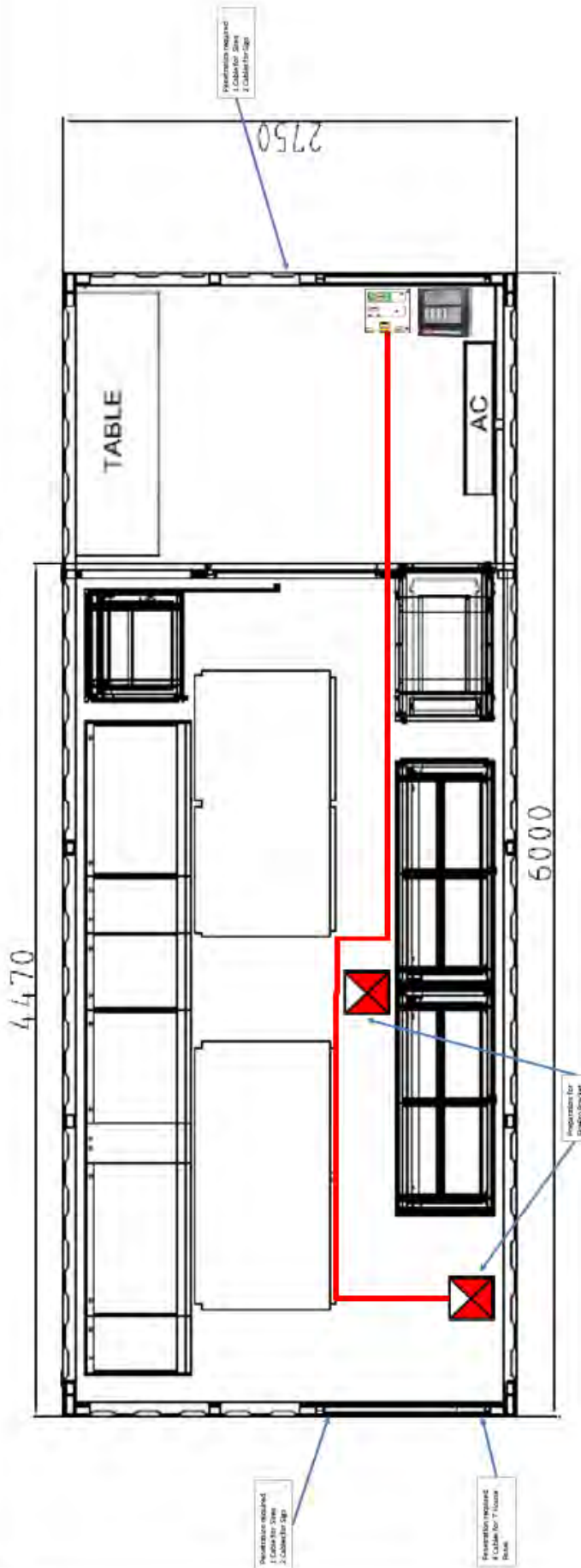

NOTES:

- 1 All cable to be (Except for incoming 230VAC power supply)
 - ★ Fire Rated to 120m
 - ★ Shielded
 - ★ Outer insulation RED
 - ★ Conductors to be min 0.75mm Stranded
- 2 Locations of devices are general only
- 3 Local Control Panel for T-House via FPC2
- 4 Linear Heat Detection Cable used in T-House
- 5 FPC-2 Reports Back to Sigma XT panel for Fire and Faults
- 6 Sigma XT Panel reports to AFP-3030 Panel
- 7 AFP-3030 takes Fire/Fault signal from Sigma XT, all circuits supervised.
- 8 Power to FIP AFP-3030 and Sigma XT 230AC
- 9 ACTIVATION TO BE BASED ON both Thermal and Smoke Detectors in Alarm
- 10 Shutdown to be based on EITHER Thermal or Smoke Detectors in Alarm
- 11 On Alarm, Estop to be activated and all AC to be Shutdown

BILL OF MATERIALS	
SYMBOL	DESCRIPTION
	2 FirePro Aerosol Generator - 3000G
	3 Flashin! Siren / Strobe
	4 Hochiki 609C RoR Thermal Detector
	4 Hochiki Photo Electric Smoke Detector
	1 Sigma XT - 2 Zone Conventional FIP
	1 AFP 3030 Fire Indicator Panel
	#REF! Local Control Station
	2 Sign - Fire Alarm - Evacuate Area
	2 Sign - Fire Alarm - Do Not Enter - WP
	2 Sign - System Inoperative

Drawn By	FM	Date	17-03-09
FIRE SAFETY EQUIPMENT PVT LTD Title			
Cargotec Morebank		Drawing No ASC3	
ASC E House Fire Suppression System		Rev.5	

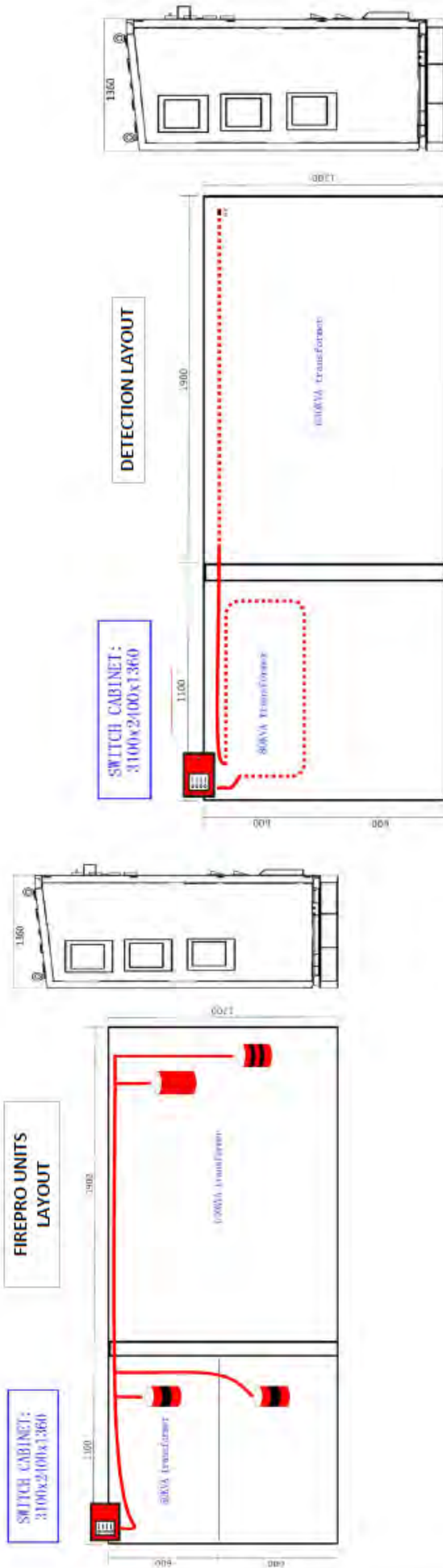

NOTES:

- 1 Separate Sub Fire Indicator Panel - which will control this Risk.
- 2 Sub FIP will report back to Sigma XT FIP in Ehouse for Fire and Fault.
- 3 FirePro Aerosol Generators are controlled via Sub FIP Panel
- 4 Detection using Linear Heat Detection Cable UL Listed - 185deg C for Activation.
- 5 Power coming from Sigma FIP which is Battery Backed.
- 6 ACTIVATION TO BE BASED Linear Heat Detection Cable in Alarm
- 7 Shutdown to be based on signal from Sigma XT FIP
- 8 On Alarm, Estop to be activated and all AC to be Shutdown
- 9 Locations of devices are general only
- 10 All cable to be (Except for incoming 230VAC power supply)
 - † Fire Rated to 120m
 - † Shielded
 - † Outer insulation RED
 - † Conductors to be min 0.75mm Stranded

BILL OF MATERIALS	
SYMBOL	DESCRIPTION
	1 Linear Heat Detection Cable 185Deg C - 1 m
	1 Linear Heat Detection Cable 185Deg C - 2 m
	1 FirePro Aerosol Generator - 100G
	2 FirePro Aerosol Generator - 200G
	1 FirePro Aerosol Generator - 500G
	1 FP-C2 Sub Fire Indicator Panel

Drawn By TM	FIRE SAFETY EQUIPMENT PTY LTD Title	
Date 21-05-08	Cargotec Morebank ASC T House Fire Suppression System	Drawing No ASC4 Rev.5