

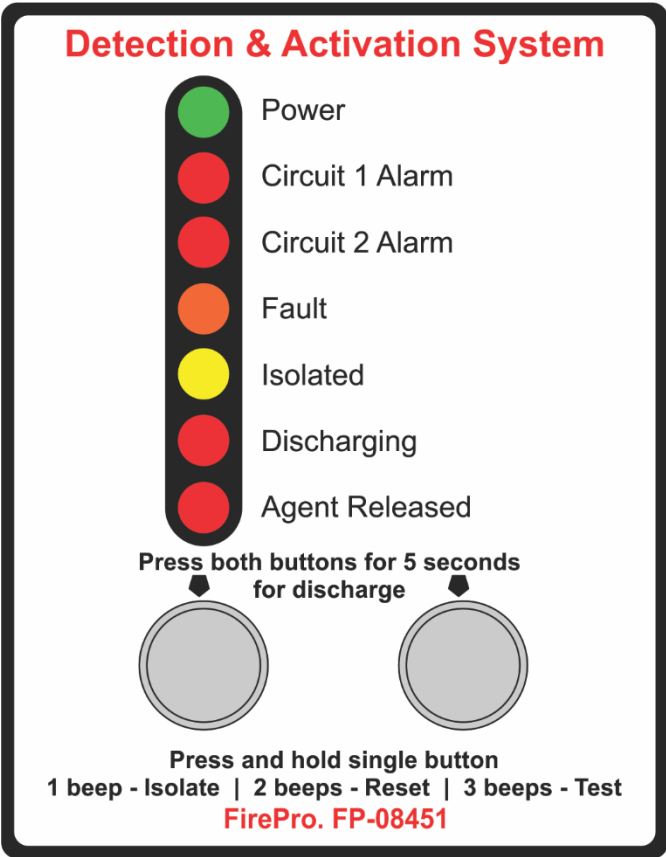

Reinventing
Fire Suppression

Fire Detection and Activation System Model 08451

Rev 2.5



Global-Mark.com.au®
ID Number: 103334

Contents

1	Introduction	3
	1.1 General Information	3
	1.2 How Does it Work	3
	1.3 In Case of Fire	3
2	Components List	4
3	Design Considerations	5
	3.1 Power Supply Input	5
	3.2 Agent Released Input	5
	3.3 Siren/Strobe Output	5
	3.4 Discharge Output	5
	3.5 Circuit 1 Alarm Output	6
	3.6 Circuit 2 Alarm Output	6
	3.7 Mounting	6
	3.8 Cabling Requirements	7
	3.9 Connecting Multiple FirePro Generators	7
4	Installation	8
5	Wiring Diagram	11
6	Programming	12
7	Operation	12
	7.1 LED Indicators	12
	7.2 Isolate Function	12
	7.3 Reset Function	13
	7.4 Test Function	13
	7.5 Discharging the Fire System	13
	7.6 Alarm Silence	13
8	Commissioning and Test Procedure	14
9	Servicing and Maintenance	16
	9.1 Daily Service Schedule	16
	9.2 Semi-annual / Annual Service Schedule	16
10	Troubleshooting	17
	10.1 Internal Faults	17
	10.2 External Faults	17
	10.3 Agent Released Light is lit	17
11	Specifications	18
12	RFI Environments	19
13	Safety Data Sheet (SDS) - FirePro	19
14	Vehicle and Mobile Plant Installation Notes (AS5062)	20
15	Marine Installation Notes (AMSA NSCV)	21

1 Introduction

1.1 General Information

The FirePro FP-08451 Fire Control Panel is a combined detection and extinguishant system, and is compliant for use in both marine (AMSA NSCV) and vehicle installations (AS5062).

The FIP (fire indicator panel) incorporates:

- 2x Detection circuits;
- 1x Extinguishing Discharge circuit;
- 1x Siren/Strobe circuit;
- 1x Agent Release Notification circuit;
- Programmable Activation (automatic and/or manual);
- Fault Monitoring system;
- Isolation Function.

1.2 How Does it Work

All **FirePro** Aerosol Generators use the latest generation FPC solid compound. Upon activation, the solid compound is transformed into a rapidly expanding, highly efficient gas, based on Potassium salts. It does not deplete oxygen levels. **The built-in fail-safe activation system** ensures operation of the generators when required, even if everything else fails. At 300°C the FPC block changes to a potassium-based gas to extinguish the fire.

Ozone Depletion Potential (O.D.P.) = 0

Atmospheric Life Time (A.L.T.) = 0

Global Warming Potential (G.W.P.) = 0

Non-corrosive & Non-toxic

1.3 In Case of Fire

If a fire occurs, equipment operators should do the following:

1. Detection will initiate an alarm condition on the FirePro System
2. The siren/strobe will operate and if shutdown relays have been installed, equipment shutdown will be initiated.
3. Evacuate all personnel from the risk area and alert the Fire Brigade.
4. Close all hatches and openings, and shutdown engines and any extraction fans or vents.
5. **Manual Activation:** Press and hold both mode switches continuously for 5 seconds to activate the system.
6. **Automatic Activation:** The control panel will automatically begin the activation sequence when fire has been detected on Circuit 1 Alarm.
7. Keep the FirePro suppression gas within the risk until the fire is extinguished and not able to re-ignite.
8. Do not start engine or fans until the fire is extinguished. Operating the exhaust fans will enable the gas to escape the risk area and could allow the fire to re-ignite.
9. Do not enter the risk until it has been rendered safe.
10. Recommended clean up after discharge is with soapy water and a cleaning agent based on citric acid.
11. Following a discharge, replace all installed FirePro Generators and Thermal Fuse Couplings.

2 Components List

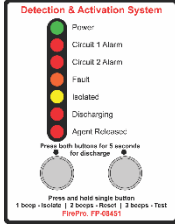

FP-08451
Fire Control Panel
 Detection and extinguishant control system

- 2x DP-3000 Deutsch Plug 3 Pin M/F, c/w heatshrink
- 4x DP-2000 Deutsch Plug 3 Pin M/F, c/w heatshrink
- 2x FP-08950 End-of-line Plug 22kΩ (Detection)
- 1x End-of-line Diode 1N4004 (Siren/Strobe)
- 1x End-of-Line Resistor 3k3Ω (Discharge)
- 1x Operator's Manual

Agent Release Circuit



FP-08825
 Thermal Fuse Coupling
 See 3.2 Agent Released

Siren / Strobe Circuit



FP-08940
 Siren/Strobe

Discharge Circuit



FirePro Aerosol Generator
 100g – 500g Unit.
 Constructed from Stainless Steel.
 Comes with installed Deutsch Plug for easy install



FP-6200
 Heavy Duty Bracket 316 SS.
 Suits FP-100, 200, 500 FirePro Aerosol Generators.



FirePro Aerosol Generator
 1200g – 5700g Unit.
 Constructed from Stainless Steel.
 Comes with installed Deutsch Plug for easy install.



FP-6100
 Heavy Duty Bracket 316 SS.
 Suits FP-1200, 2000, 3000 5700 FirePro Aerosol Generators.

Detection Circuit (Circuit 1 Alarm & Circuit 2 Alarm)



FP-08920
 Marine Grade Thermal Detector
 60°C Fixed. Other temperatures available on request.



FP-14053
 Manual Actuator
 Internal OR External



FP-09510
 Linear Heat Detection Cable 182° C

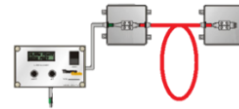

FP-09511
 Linear Heat Detection Installation kit.
 Mounting Clips, 2x Junction Boxes with strain relief cable glands and 1x EOL for monitoring.

Installation Components



FP-09500
 2 Hour Fire Rated Shielded Cable.

Service Components



FP-08960
 Signage for the System. A sheet of different size labels.



FP-08919
 Wiring loom and Splitter Cable for installaion of multiple FirePro generators.



FP-08800
 FirePro Simulator – for Testing & Commissioning.

Additional Modules



FP-08850
 Discharge Delay Module
 Allows additional FirePro generators to be discharged



FP-08860
 Shutdown Relay Module
 Provides facility for equipment shutdown



FP-08870/8871/8872
 Power Control Module
 Provides back up power for control panel.

3 Design Considerations

3.1 Power Supply Input

The FP-08451 Fire Control Panel provide a single power supply input that is compatible with 12 / 24vDC. If adequate power is not supplied, the LEDs will not be illuminated, and the control panel will not operate. The main power supply should be connected directly to a battery or power source, not through a distribution board. The main power **must not** be interrupted if the vehicle/equipment is powered down. The FirePro Battery Lead (P/N FP-14016) may be used to connect power to the control panel. If a secondary power supply is required for an installation, the FP-08870/08871 Power Control Module will be required.

3.2 Agent Released Input

The Agent Released input provides an indicator to the operator to notify if the suppression system has been activated. For the indicator to operate, the FP-08825 Thermal Fuse Coupling must be used. Thermal Fuse Couplings are single use only. If the suppression system has operated, the thermal fuse coupling must be replaced. If the Agent Release output is not used, the circuit must be bridged out and sealed using the supplied deutsch plugs.

3.3 Siren/Strobe Output

The recommended siren/strobe is the Flashni Xenon Sounder Beacon. In a typical install, the maximum number of supported sirens/strobes that can be installed is 5. When installed, Siren/Strobes are to be clearly visible and audible at all points around the risk area.

The siren/strobe output is a monitored circuit. The supplied end-of-line diode (1N4004) must be installed on the last siren/strobe in the circuit, otherwise the fire control panel will display a fault. If a siren/strobe is not used, the supplied end-of-line diode (1N4004) must be connected to the siren output using the supplied deutsch plugs.

3.4 Discharge Output

The maximum number of FirePro generators able to be discharged by the FP-08451 Fire Control Panel is limited by the voltage of the main power supply. That is:

Voltage 12vDC Max = 2 Units	Voltage 24vDC Max = 4 Units
------------------------------------	------------------------------------

If a risk area requires a greater number of FirePro generators to be discharged than the standard panel can provide, the FP-08850 Discharge Delay module can be used. The module will discharge generators in multiples up to the maximum as above.

If the number of FirePro generators connected to each output is greater than the maximum, the fire system will not operate.

When multiple FirePro generators are connected to a single output, they **must** be connected using the FP-08919 Splitter Lead (see 3.9 Connecting Multiple FirePro Generators).

If a suppression system is not used, the supplied end-of-line resistor (3k3Ω) must be connected to the Discharge output using the supplied deutsch plugs.

3.5 Circuit 1 Alarm Output

The Circuit 1 Alarm Output is a zoned detection circuit capable of operating up to 30 conventional detectors, 100 metres of linear heat detection cable or 30 manual actuators.

The Circuit 1 Alarm Output can be programmed for detection and alarm, or for automatic discharge if an alarm is detected on this circuit (see 6. Programming).

The supplied end-of-line resistor (22kΩ) must be installed on the last detector or manual actuator in the circuit, or the fire control panel will display a fault. If detection is not used, the supplied end-of-line plugs (marked green) must be connected to the Circuit 1 Alarm output.

3.6 Circuit 2 Alarm Output

The Circuit 2 Alarm Output is a zoned detection circuit capable of operating up to 30 conventional detectors, 100 metres of linear heat detection cable or 30 manual actuators.

The Circuit 2 Alarm Output is a detection and alarm circuit only. When in alarm condition the siren/strobe will operate, however the suppression system will not discharge until manually operated.

The supplied end-of-line resistor (22kΩ) must be installed on the last detector or manual actuator in the circuit, or the fire control panel will display a fault. If detection is not used, the supplied end-of-line plugs (marked green) must be connected to the Circuit 2 Alarm output.

3.7 Mounting

For correct installation, the Fire Control Panel must be mounted by four bolts or screws through the mounting holes in the flange on both sides of the Module. **No penetrations are to be made through the casing of the panel.**

The Fire Control Panel enclosure is rated IP65, so should be installed in a convenient location, away from where it may be affected by large amounts of water.

It is necessary to complete all wiring and any programming of the detection mode prior to mounting the panel.

Dimensions and relevant clearances for installing the FP-08451 Control Panel are below. A Dash Mount Bracket (P/N FP-08451B) is also available and may be used if the minimum clearances cannot be met.

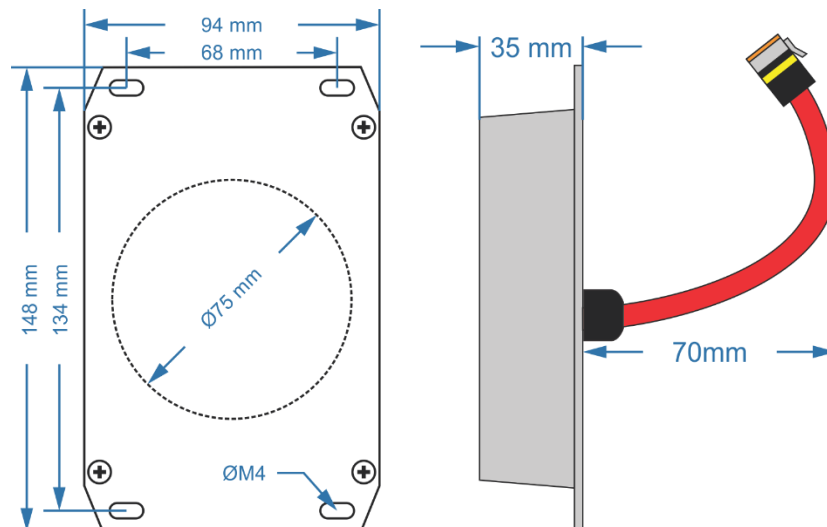

3.8 Cabling Requirements

When constructing extension leads the supplied Deutsch Plugs must be used to ensure waterproof connections are made throughout the installation.

1. Cut cable to required length and strip outer insulation to approximately 25-30mm.
2. Strip inner insulation to approximately 6mm and using a Deutsch Crimping tool, fix pins to the exposed ends of the cable, including the earth where applicable.
3. Place heat shrink over the end of the cable. Identify correct socket on plug by the numbers/letter on the side of the plug and push through the gasket at the bottom of the plug until a click is heard and the pin is locked in place.
4. Place the locking mechanism inside the plug to ensure pins remain secure. (Male plugs; locking mechanism is orange. Female plugs; locking mechanism is green).
5. Using the heat shrink, seal the back of the plug.

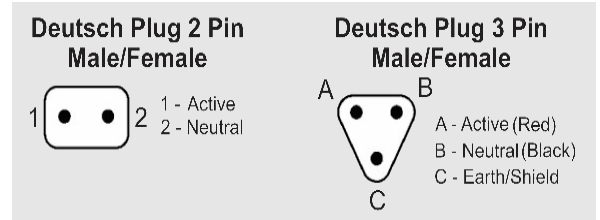

Cables are colour coded for easy identification. When installing system, cables should be only connected to the correctly coded cable. Colour Coding for cables is as follows:

Colour	Circuit
Red	Power Supply
Yellow 1	Activation
Yellow 2	Activation Delayed
Green 1	Detection 1
Green 2	Detection 2
Blue	Discharge Advice
Orange	Siren/Strobe
White	Relay Output

3.9 Connecting Multiple FirePro Generators

If multiple FirePro Generators are being installed on a single output, they must be connected using the FP-08919 Splitter Lead. The Splitter Lead enables the activation current to pass uninterrupted to all connected FirePro generators and allows for continuous monitoring.

Splitter Leads can be installed at any point on the activation circuit and do not need to be installed adjacent to the fire control panel or the discharge delay module. For ease of install, servicing and more efficient field wiring, Splitter Leads should be installed in areas easy to access and should be used to minimise the required extension leads, and to bypass obstacles.

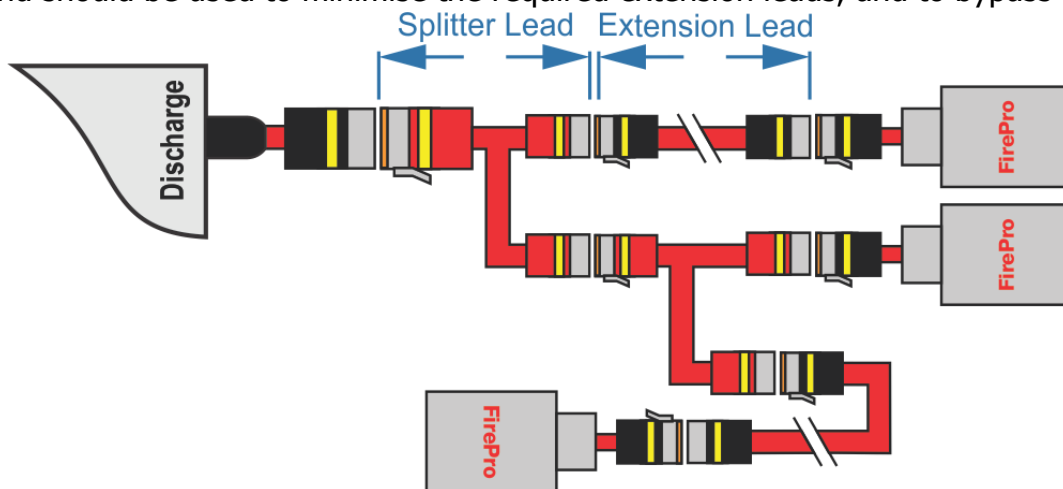

4 Installation

FirePro generators **must** remain disconnected until system is completed and fire control panel is no longer in a fault or alarm condition. The FirePro Test Module (P/N FP-08800) can be used to take the panel out of a fault condition.

Note: Any required extension leads **must** be constructed as per the instructions in 3.8 Cabling Requirements.

Note: It is recommended that one circuit is installed and connected at a time to isolate the cause of any faults that may occur during installation. The supplied End-of-line plugs and Test Module may be used to keep the control panel out of a fault condition.

1. **Power:** When panel has been mounted in a suitable location, connect main supply power using a FP-14016 Battery Lead to the power input (marked red).

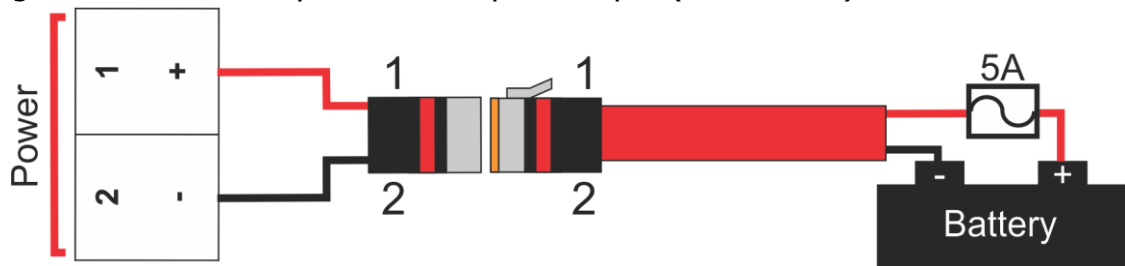

2. **Agent Released Circuit:** The Thermal Fuse Coupling (P/N FP-08825) should be screwed into the thermal port on one of the installed FirePro generators and connected to the control panel.

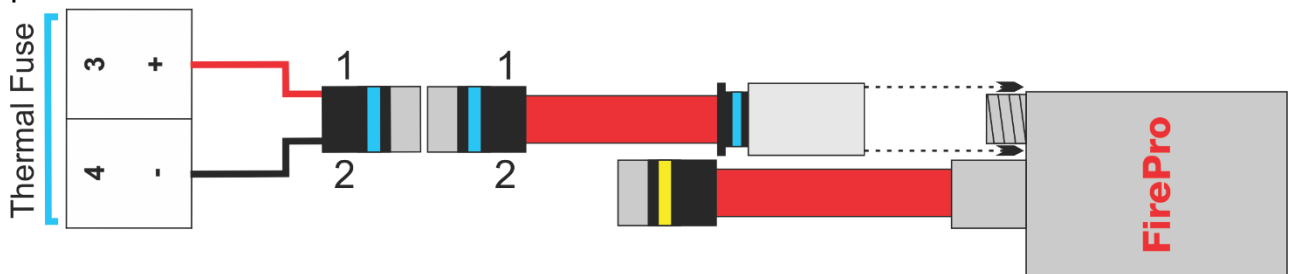

3. **Siren/Strobe Circuit:** Mount the siren/strobe (P/N FP-08940) in a location where it is visible and audible in all points with the risk area and connect to the "Siren" output on the module (marked orange). If more than one siren/strobe is being installed, they are to be connected using the secondary positive/negative terminals in the sounder.

The supplied end-of-line diode should be installed in the secondary positive/negative terminals of the last siren/strobe in the circuit. The diode is polarised, so the positive lead of the diode (marked with a grey band) should be terminated in the positive terminal of the siren/strobe, otherwise a fault will occur on the fire control panel.

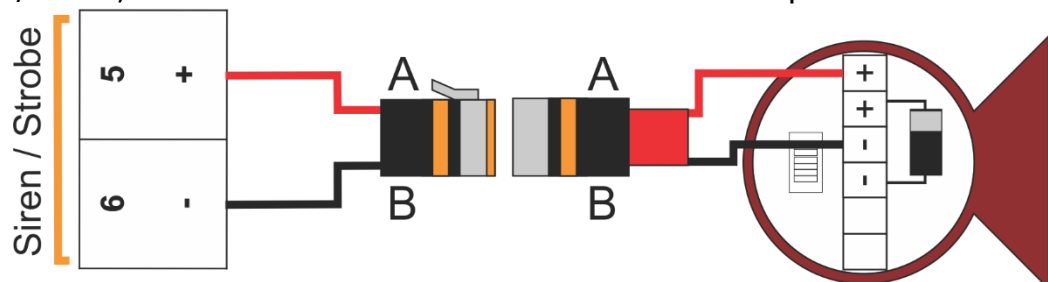

4. **Circuit 1 Alarm Circuit:** This circuit can be programmed for **ALARM ONLY** (operate siren/strobe) or **AUTOMATIC DISCHARGE** (discharges suppression system and operates siren/strobe). If detection is not used, the supplied end-of-line plugs (marked green) must be connected to the Circuit 1 Alarm output.

- **Manual Actuator** (P/N FP-14053) can be connected together in quantities up to 30. If a manual actuator is being used for remote activation, it **must** be installed on Circuit 1 Alarm. The supplied end-of-line plugs (marked green) must be connected to the last manual actuator in the circuit.

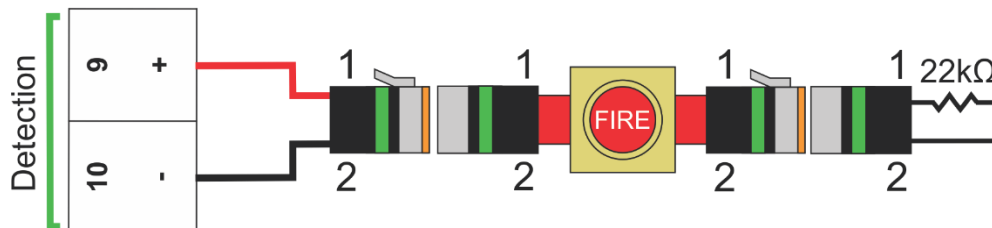

- **Linear Heat Detection:** Linear Heat Detection can be installed in lengths up to 100m. Any terminations of cable must be enclosed using sealed, metal enclosures from the LHD Install Kit (P/N FP-09511). P-Clips must be installed at intervals of 50cm maximum to support the cable. The supplied End-of-line junction box must be installed on the end of the cable.

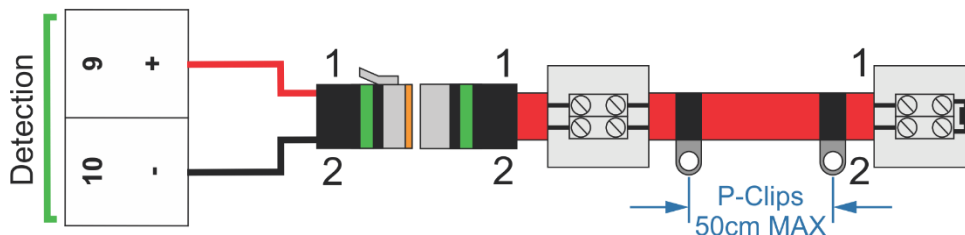

- **Conventional Detector (Thermal / Smoke):** Conventional Detector (P/N FP-08920 Thermal / FP-94140 Smoke) can be connected together in quantities up to 30. A 22kΩ End-of-line resistor must be installed in the last detector in the circuit.

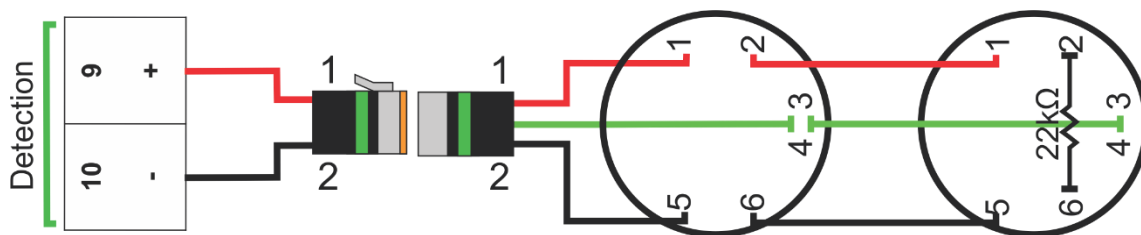

- **Detection Not Used:** If detection is not used, the supplied end-of-line plugs (marked green) must be connected to the Circuit 1 Alarm output.

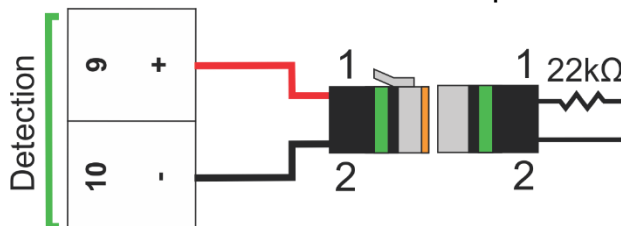

5. **Circuit 2 Alarm Circuit:** This circuit is **ALARM ONLY** and will only operate the siren/strobe. Connections for detection and manual actuators are the same as Circuit 1 Alarm. If detection is not used, the supplied end-of-line plugs (marked green) must be connected to the Circuit 2 Alarm output.
6. **Discharge Circuit:** This circuit should remain disconnected until all other circuits are connected. The control panel **must not** be in an alarm/fault condition when the FirePro generators are connected, as this may cause an accidental discharge. A FirePro Test Module (P/N FP-08800) should be connected to take the control panel out of fault condition and for any commissioning.
 - **Mounting FirePro Generators:** FirePro Generators must be installed using only approved brackets **with observation of the relevant stream lengths and thermal clearances** noted in the design calculation and risk assessment. Generators should be mounted near the top of the risk area, with care taken to aim generators away from openings or obstacles that may impede dispersion of the suppression agent. Egress routes for personnel must be kept clear, and not be obstructed by any installed components or by agent dispersion.
 - **Connecting FirePro Generators:** If a single FirePro Generator is being installed, it can be connected directly to the Discharge output on the control panel.

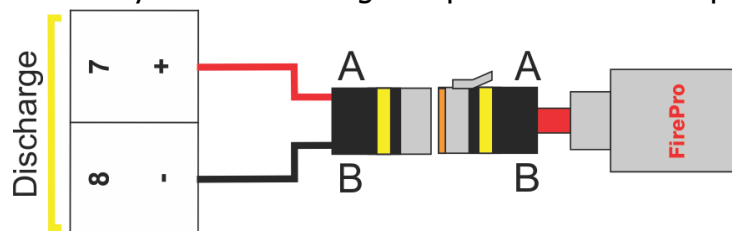

If multiple FirePro Generators are being installed on a single output, they must be connected using the FP-08919 Splitter Lead. See 3.4 Discharge Output, for design considerations when connecting multiple FirePro generators. The maximum number of FirePro Generators that can be connected will depend on the main power supply.

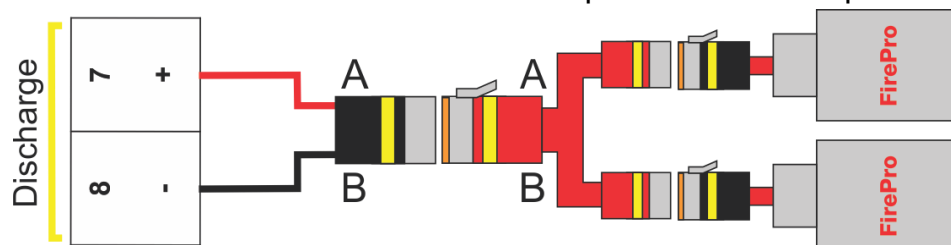

- **Discharge Not Used:** If the discharge circuit is not used, the supplied end-of-line resistor ($3k3\Omega$) must be connected to the Discharge output using the supplied deutsch plugs.

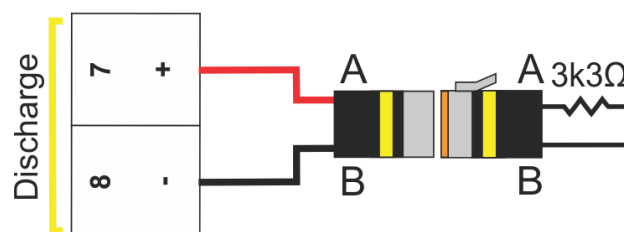

5 Wiring Diagram

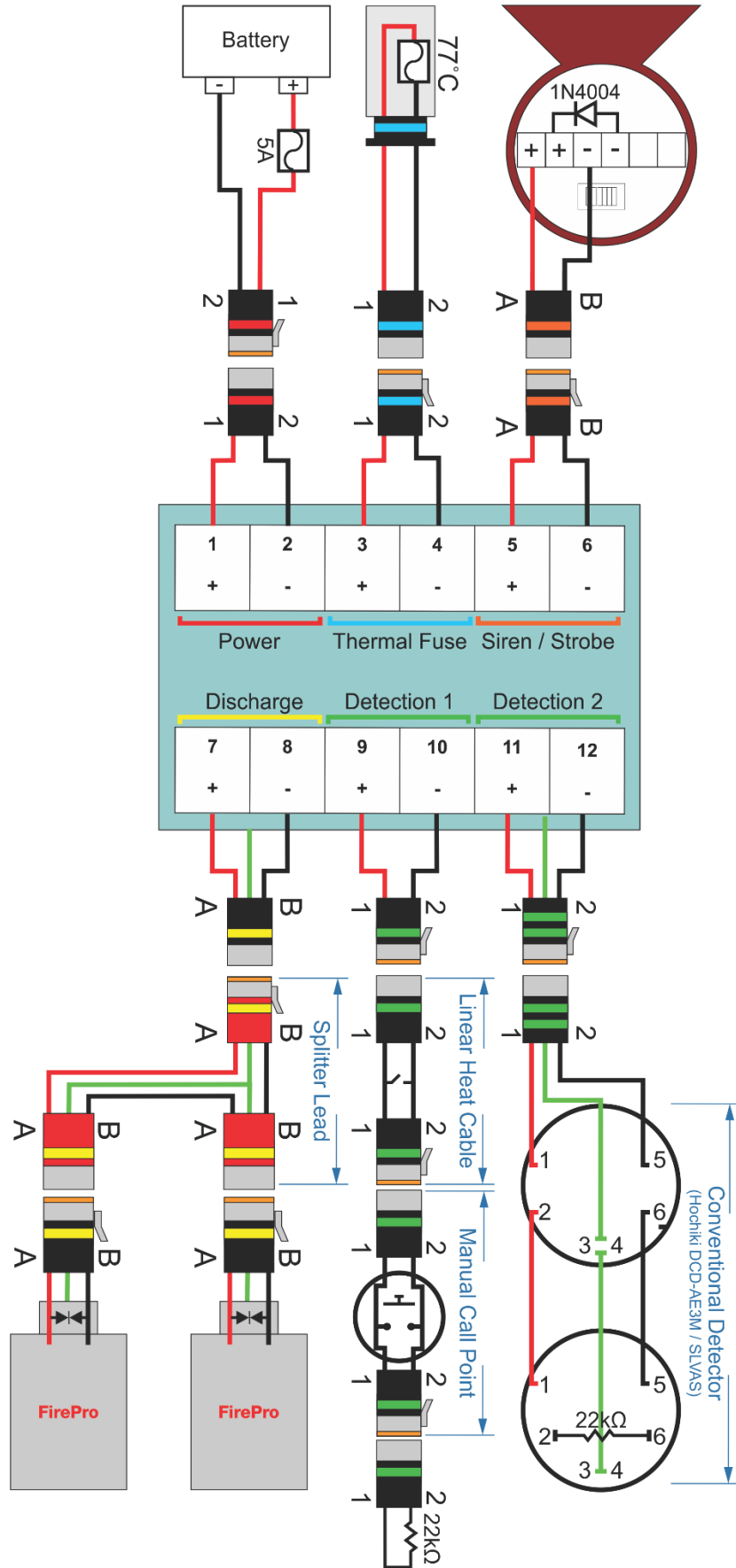

6 Programming

The FP-08451 Control Panel provides several programming options, allowing it to be adapted to site conditions. The 2-way DIP switches inside the panel next to the terminal block allow one of 4 modes to be selected. To access the DIP switches, open the panel enclosure.

Note: All programmed settings should be recorded in the logbook.

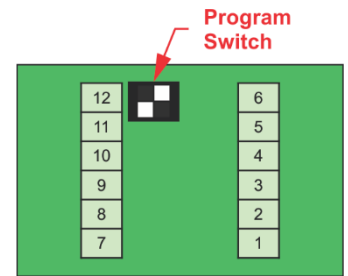

Switch 1	Mode	Switch 2	Mode
	Standard Discharge Power Applied for 2 seconds DEFAULT		Manual Discharge Detectors operate siren/strobe only
	Extended Discharge Power applied for 240 seconds		Automatic Discharge Detection on Circuit 1 Alarm will discharge system DEFAULT

Note: If a Discharge Delay Module (P/N FP-08850) is installed, panel **must** be programmed for extended discharge.

7 Operation

7.1 LED Indicators

The FP-08451 Control Panel uses LED indicators to notify the operator of the condition of the control panel and each of the monitored circuits. If an LED is illuminated, it indicates the following:

Circuit	LED	Condition
Power	Green	Power supply is available
Circuit 1 Alarm	Red	System is in alarm condition
Circuit 2 Alarm	Red	System is in alarm condition
Fault	Yellow	System is in fault condition and needs servicing
Isolated	Yellow	System has been isolated using buttons on panel
Discharging	Red	System has initiated activation sequence
Agent Released	Red	Agent has been released and needs servicing

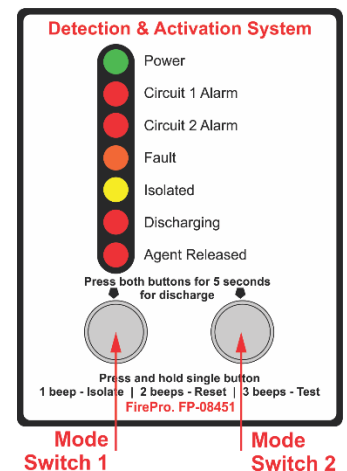

7.2 Isolate Function

To isolate the control panel, press and hold Mode Switch 1 until a 1 beep is heard and the "Isolated" LED is illuminated.

To restore the control panel to normal operation, press Mode Switch 1 and ensure the "Isolated" LED turns off.

Isolating disables automatic activation. Manual Activation will remain operational.

When isolated, the control panel continues to monitor for alarm and fault, and show the alarm and fault indications, but will not operate the siren and the automatic discharge. When isolated, any change in the detector status, will cause the panel sounder to operate for 1

second as an alert of the status change, but the panel will remain isolated.

The isolate function will also silence the siren/strobe and the internal sounder but will not cancel the alarm or fault indication.

7.3 Reset Function

To reset the control panel, press and hold Mode Switch 1 until 2 beeps are heard. Following a reset, the control panel will automatically isolate. To restore the control panel to normal operation, press Mode Switch 1 and ensure the "Isolated" LED turns off. **Note:** The control panel **cannot** be reset if the activation sequence has been initiated. When the "Discharging" LED is no longer illuminated, the reset function will become available again.

7.4 Test Function

The control panel includes a test function, enabling the operator to ensure that the control panel is functioning correctly. To operate the test function, press and hold Mode Switch 1 until 3 beeps are heard. The test function will illuminate all LEDs on the control panel and operate the internal sounder and any external siren/strobes for 2 seconds, and then return the control panel to normal operation. The test function does not activate the suppression system. **Note:** If any LEDs or siren/strobes do not operate, contact your supplier.

7.5 Discharging the Fire System

To manually discharge the fire system, press and hold both Mode Switch 1 and Mode Switch 2 continuously for 5 seconds. This will immediately operate any installed siren/strobes and any shutdown relays, to warn any occupants. Manually discharging the fire system should only be performed during commissioning/servicing when the system has been appropriately isolated, or in case of fire.

7.6 Alarm Silence

To silence the internal sounder and any installed siren/strobes that have operated due to an alarm condition, press and hold Mode Switch 1 until a 1 beep is heard and the "Isolated" LED is illuminated. This will also override any installed shutdown relays and allow for operation of the equipment. **Note:** Equipment should not be operated until it has been rendered safe by the appropriate authority. The control panel will remain in an alarm/fault condition until serviced and reset.

8 Commissioning and Test Procedure

Commissioning should be performed when the fire control panel is not in an alarm/fault condition. **Note:** No personnel should be in the risk area until the fire system is fully isolated. To ensure that the FirePro system will operate as designed, it should be inspected and serviced every 6 months, and yearly, in accordance with AS1851 and AS5062.

Six Monthly Test Procedure:

1. Isolate the control panel (see 7.2 Isolate Function) and disconnect the any installed FirePro aerosol generators. This will generate a fault on the fire control panel.
2. Connect a FP-08800 Test Module to the "Discharge" output to the panel (marked yellow). Turn off the Isolate function. The Test Module should remain installed throughout the test procedure.
3. Control Panel and components
 - Clean and remove dirt, grease or foreign material. Replace any parts that appear damaged or have been painted.
 - Check all indicators are in normal position.
4. FirePro Aerosol Generators
 - Inspect FirePro generators to ensure they are in good condition.
 - Check mounting brackets are in good condition and secure.
 - Check Dust Covers are in good condition – replace as necessary.
 - Check FirePro Units are at predetermined aiming points.
5. Electrical system – Inspection
 - Check Manual Actuators are secure, clean, undamaged.
 - Check that anti-tamper seals/pull pins are in place and secure.
 - Check all wiring, connection and supports are in intact, not damaged and in correct position.
6. Labels –
 - Check manual release, system warning and instruction labels are securely in place, visible and legible.
7. Test the fault monitoring system by disconnecting and reconnecting all connected detection devices and the siren strobe circuit one at a time. Ensure the "Fault" LED indicator illuminates and the internal sounder is heard each time a circuit is disconnected.
8. **Discharge Testing from Control Panel:**
 - Perform a manual discharge test by pressing and holding both mode switches on the panel continuously for 5 seconds.
 - Following activation, ensure the Test Module Red LED has operated.
 - Isolate the panel to silence alarm. Panel should now display a fault.
 - Reset Test Module. Panel should no longer be in fault condition.
 - Turn off the Isolate function.

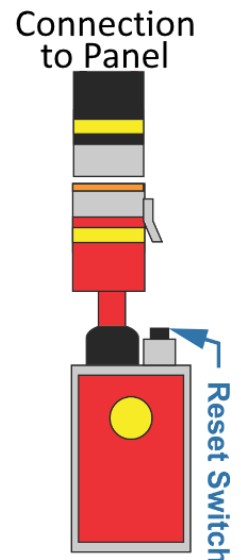

9. **Discharge Testing from External Devices:** Each detection and manual actuator device connected to must be tested individually.
- Perform an automatic discharge test by activating the detectors or manual actuators.
 - Following the activation sequence ensure the Test Module Red LED has operated.
 - Isolate the panel to silence the alarm. The control panel should now display a fault.
 - Reset the Test Module.
 - Reset the control panel by pressing and holding a single mode switch until 2 beeps are heard. The control panel should no longer be in alarm/fault condition.
10. **System control and indicating equipment.**
- During discharge test, ensure operation of all installed siren/strobe(s).
 - During discharge test, ensure operation of all installed shutdown relays. This must shutdown any equipment specified in the risk assessment.
 - Test backup battery capacity. Replace every backup battery every 2 years.
11. Disconnect the FP-08800 Test Module and reconnect all FirePro aerosol generators.
12. Turn off the Isolation function. System is now operational.

Additional requirements for Commissioning of a System after Install or Discharge

13. **Design Survey** - check against the baseline data, for alterations, changes in use or operating environment, or other factors that could affect the performance of the fire protection system. (Annual)
14. **Risk Assessment** – required to be prepared and reviewed every 5 years or after any incident. Review document to ensure system compliance. Check if document is current.

9 Servicing and Maintenance

Inspection and servicing of the installed fire system should occur in accordance with the relevant Australian Standards (i.e. AS1851 or AS5062). Any alterations to the risk area should be recorded and where necessary the risk assessment, design calculation and installed components must be revised to reflect the new operating conditions.

A logbook must be kept, recording all the relevant information from the installation and servicing. The logbook must contain the following:

Content of logbook:	Appendices of Logbook:
<ul style="list-style-type: none">- General details- Devices used- Date and outcome each inspection- Risk Assessment	<ul style="list-style-type: none">- Schematic diagrams- Photos of the original Installation- Programming of the control panel- Inspection reports

9.1 Daily Service Schedule

A daily inspection should be performed by the operator prior to operation of the equipment. If anything does not appear normal, the equipment should not be operated and the fire service provider alerted. The Daily Inspection should include:

- Visual inspection of the control panel and installed components. These should be accessible and free from debris, rust, or electrical faults.
- Visual inspection of the control panel to ensure normal functioning. When functioning normally the only indicator illuminated should be the "Power" indicator (green).
- Visual inspection of anti-tamper seals and travel pins, to ensure they are in place.

9.2 Semi-annual / Annual Service Schedule

Semi-annual and Annual servicing and maintenance **are to be undertaken only by accredited service technicians**. Any misuse of the FIP may result in an accidental discharge of the suppression system and is not covered by warranty.

Servicing should include a visual inspection of all the installed components to ensure they are in good condition, and that the relevant stream lengths and thermal clearances are observed as per the original design calculation and risk assessment.

Operation of the fire system should be tested as outlined in 8. Commissioning.

10 Troubleshooting

The FP-08451 Control Panel provides a comprehensive fault monitoring system that will detect any open-circuit in the Circuit 1 Alarm Output, Circuit 2 Alarm Output, Siren/Strobe Output, Discharge Output and Agent Released Input and any malfunctions of the control panel's internal components.

When in a fault condition, the control panel will operate the "Fault" LED indicator and operate the internal sounder. The control panel uses a coded sequence to indicate the type circuit to the operator. **Note:** To diagnose if a fault is internal or external, attempt to isolate the panel. If the control panel can be isolated, the fault is external. (see 7.2 Isolating the Control Panel)

10.1 Internal Faults

An internal fault cannot be isolated and will display as:

Internal Sounder	Fault LED	Fault
Continuous, steady beep	On	Internal 5vDC Supply OR Watch Dog Circuit
Continuous, pulsing beep	On	Internal Microprocessor

Internal faults can be rectified by powering down the panel and powering up again. This will reset the system to normal conditions. If the fault persists, contact your supplier.

10.2 External Faults

An external fault can be isolated and will display as:

Internal Sounder	Fault LED	Fault
1 beep	On	Circuit 1 Alarm
2 beeps	On	Circuit 2 Alarm
3 beeps	On	Discharge Circuit OR Siren/Strobe Circuit

External faults will require inspection and testing of connections and installed components. End-of-line plugs should be plugged directly into the panel, to return it normal condition, and then used to systematically check along the effected circuit(s). If the fault persists, contact your supplier.

10.3 Agent Released Light is lit

See clause 3.2. This would indicate that the thermal fuse coupling has either activated as designed – OR the thermal fuse has failed, and will need to be replaced.

11 Specifications

General	Dimensions	148L x 84W x 35D mm	
	Material	Diecast Aluminium, UV Tolerant	
	Ingress Protection	IP65	
	Operating Temperature	-40 to 85 degrees Celsius	
	Fault Monitoring – External	<ul style="list-style-type: none"> - Circuit 1 Alarm – Open/Closed - Circuit 2 Alarm – Open/Closed - Siren/Strobe – Open/Closed - Discharge – Open/Closed 	
	Fault Monitoring – Internal	<ul style="list-style-type: none"> - Poly-switch fuse operated - Loss of internal 5V supply - Internal microprocessor malfunction 	
Power Supply Input	Mains Operating Voltage	12-30VDC	
	Mains Operating Current	20mA on 12V	23mA on 24V
	Backup Power	See FP-08870 / 08871 / 08872 manual	
Detection Output Circuit 1 Alarm & Circuit 2 Alarm	No. of Detection Zones	2	
	Operating Voltage	12-30VDC (same as main supply voltage)	
	Detection End-of-line	22kΩ Resistor	
	Maximum Detectors per Zone	<ul style="list-style-type: none"> - 30 Conventional Detectors - 100m Linear Heat Detection - 30 Manual Actuators 	
	Alarm Threshold	3.6V Fault sensing threshold: 0.53V	
	Compatible Detectors	Hochiki SLV-AS Smoke Detector Hochiki DCD-AE3M Thermal Detector 14053 Manual Actuator 09510 180°C Linear Heat Detection	
Discharge Output	Discharge Output Current	2A at 12VDC	4A at 24VDC
	Discharge End-of-line	3K3Ω Resistor	
	Maximum FirePro Generators	2 in series at 12VDC	4 in series at 24VDC
	Standard Discharge Delay	5 seconds from automatic/manual activation	
Siren/Strobe Output	Siren/Strobe Output Current	Max 0.5A	
	Siren/Strobe Output Protection	0.5A poly-switch resettable fuse	
	Siren/Strobe End-of-line	1N4004 Diode	
	Maximum Siren/Strobes	5	
	Compatible Siren/Strobes	Flashni Xenon Sounder Beacon	
Agent Released Input	Input Type	Thermal Switch, NC, Latching, Non-resettable	
	Operation	Thermal Event >80°C	

The Flashni is an audible and visual device which requires one single installation point. This greatly reduces installation costs and is less obtrusive than two separate devices. Versions are available with the sounder and beacon linked, or with separate terminals for independent operation.

Technical Specification

Voltage	9 - 15Vdc (12V version) 18 - 28Vdc (24V version) (**1)
Current	110mA 12V version (Typical Tone 5) 68mA 24V version (Typical Tone 3)
Sound Output	103dB(A) 12V version (Typical Tone 5) 101dB(A) 24V version (Typical Tone 3)
Tones	Pre-set to tone 5 (12V) Pre-set to tone 3 (24V) (versions are available with user selectable tones)
Flash Power	0.7J
Flash Rate	1Hz
Volume Control	10dB
Monitoring	Reverse polarity
Temperature	- 10°C to + 55°C
Protection	IP54 (s)* IP65 (d)**
Construction	ABS, PC lens
Weight	0.33Kg
Colours	Red or white
Lens Colour	Red, amber, blue, green or clear

(s)* Shallow Base
(d)** Deep / U Base

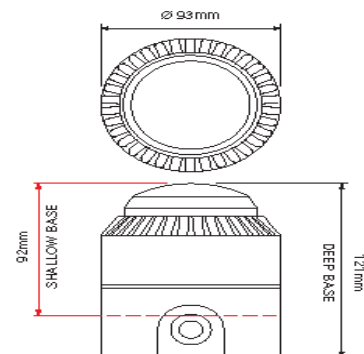



12 RFI Environments

The control panel's circuit arrangement provides a number of layers of electronic protection designed to minimise the effects of electromagnetic emissions and prevent accidental discharges of the suppression system.

Shielded, fire rated cable (FP-09500) is required to be used throughout every installation to protect the fire system from electromagnetic emissions. Cables should be installed with appropriate clearances from any cables or equipment that may produce high levels of RF interference.

13 Safety Data Sheet (SDS) - FirePro

This is an EXTRACT ONLY from the full SDS. To view the full SDS go to www.chemwatch.com.au.

	<p>HAZARDOUS SUBSTANCE. DANGEROUS GOODS. According to NOHSC Criteria, and ADG Code.</p>																														
<p>PRODUCT NAME CELANOVA FIREPRO</p>	<p>CHEMWATCH HAZARD RATINGS</p> <table border="1"> <tr> <td>Flammability</td> <td style="width: 100px;">██████████</td> <td style="width: 100px;">██████████</td> <td style="width: 100px;">██████████</td> <td style="width: 100px;">██████████</td> <td style="width: 100px;">██████████</td> </tr> <tr> <td>Toxicity</td> <td>██████████</td> <td>██████████</td> <td>██████████</td> <td>██████████</td> <td>██████████</td> </tr> <tr> <td>Body Contact</td> <td>██████████</td> <td>██████████</td> <td>██████████</td> <td>██████████</td> <td>██████████</td> </tr> <tr> <td>Reactivity</td> <td>██████████</td> <td>██████████</td> <td>██████████</td> <td>██████████</td> <td>██████████</td> </tr> <tr> <td>Chronic</td> <td>██████████</td> <td>██████████</td> <td>██████████</td> <td>██████████</td> <td>██████████</td> </tr> </table> <p>SCALE: Min/Nil=0 Low=1 Moderate=2 High=3 Extreme=4</p>	Flammability	██████████	██████████	██████████	██████████	██████████	Toxicity	██████████	██████████	██████████	██████████	██████████	Body Contact	██████████	██████████	██████████	██████████	██████████	Reactivity	██████████	██████████	██████████	██████████	██████████	Chronic	██████████	██████████	██████████	██████████	██████████
Flammability	██████████	██████████	██████████	██████████	██████████																										
Toxicity	██████████	██████████	██████████	██████████	██████████																										
Body Contact	██████████	██████████	██████████	██████████	██████████																										
Reactivity	██████████	██████████	██████████	██████████	██████████																										
Chronic	██████████	██████████	██████████	██████████	██████████																										
<p>PRODUCT USE Fire extinguishing agent.</p>	 																														

POISONS SCHEDULE - None

RISK	SAFETY
<ul style="list-style-type: none"> Contact with combustible material may cause fire. Harmful if swallowed Irritating to eyes and skin. May cause SENSITISATION by skin contact. Harmful to aquatic organisms may cause long- adverse effects in the aquatic environment. Cumulative effects may result following exposure May produce discomfort of the respiratory. system* Possible respiratory sensitiser*. May possibly affect fertility* (limited evidence). 	<ul style="list-style-type: none"> Keep away from combustible material Avoid exposure - obtain special instructions before use. To clean the floor and all objects contaminated by this material use water and detergent. Keep away from food drink and animal feeding stuffs. In case of contact with eyes rinse with plenty term of water and contact Doctor or Poisons Information Centre. If swallowed IMMEDIATELY contact Doctor or. Poisons Information Centre (show this container or label). This material and its container must be disposed of as hazardous waste.

FIRST AID MEASURES	
SWALLOWED	<ul style="list-style-type: none"> If swallowed do NOT induce vomiting. If vomiting occurs, lean patient forward or place on left side (head-down position, if possible) to maintain open airway and prevent aspiration. Observe the patient carefully. Never give liquid to a person showing signs of being sleepy or with reduced awareness. Give water to rinse out mouth, then provide liquid slowly and as much as casualty can comfortably drink. Seek medical advice.
EYE	<ul style="list-style-type: none"> If this product comes in contact with the eyes: Wash out immediately with fresh running water. Ensure complete irrigation of the eye. Seek medical attention without delay; if pain persists or recurs seek medical attention. Removal of contact lenses after an eye injury should only be undertaken by skilled personnel.
SKIN	<ul style="list-style-type: none"> If skin contact occurs: Immediately remove all contaminated clothing, including footwear. Flush skin and hair with running water (and soap if available). Seek medical attention in event of irritation.
INHALED	<ul style="list-style-type: none"> If dust is inhaled, remove from contaminated area. Encourage patient to blow nose to ensure clear passage of breathing. If irritation or discomfort persists, seek medical attention.

14 Vehicle and Mobile Plant Installation Notes (AS5062)

For AS5062 vehicle installations, a risk assessment must be completed all equipment, and the design agreed upon by the installer and operators. The risk assessment should include identification of all fuel and ignition sources, and these should be considered in the design of the fire system.

All electrical connections outside the operator's cabin are to be completed using the supplied Deutsch DT plugs or metal electrical enclosures. A minimum Ingress Protection rating of IP65 is required to be maintained throughout the installed system and components.

When installing a system for compliance to AS5062, the following is required:

Automatic Discharge: The control panel shall be programmed for automatic discharge on alarm (see 6. Programming) unless there are valid reasons determined by the risk assessment why automatic discharge would be inappropriate.

Equipment Shutdown: As determined by the risk assessment, any equipment that may impede operation of the fire system must be shutdown prior to system discharge. This requires the installation of the FP-08860 Shutdown Relay Module.

Secondary Power Supply: In addition to the power supply requirements as per 3.1 Power Supply Input, AS5062 also requires a secondary power supply capable of operating the fire system for a minimum of 24 hours. This requires the installation of the FP-08870 or FP-08871 Power Control Module (depending on available power supply), or the identification of an appropriate secondary power source in the equipment that will not be affected by any failure of the primary power supply.

System Discharge Advice: AS5062 requires independent notification to the operator if the suppression system has been discharged. This requires the installation of the FP-08825 Thermal Fuse Coupling.

Manual Actuation: As determined by the risk assessment, additional manual actuators must be installed on Circuit 1 Alarm to allow for remote manual activation of the suppression system. This requires the installation of FP-14053 Manual Actuators and Circuit 1 Alarm to be programmed for automatic discharge.

15 Marine Installation Notes (AMSA NSCV)

For AMSA marine installations, fire systems are to comply with NSCV Part C Section 4, with reference to ISO 15779: Requirements for Aerosol Systems. The following is required:

Control Panel Location: The control panel must be located in the operating compartment or another normally manned control station and have safe access that is unlikely to be blocked off in case of a fire. Instructions should be included at each control station, outlining prerequisite tasks and operation of the control panel in case of fire.

Manual Discharge: The control panel shall be programmed for manual discharge on alarm (see 6. Programming). Automatic discharge on alarm is not to be used.

Where remote actuation is needed, the FP-14053 Manual Actuator may be installed, and Circuit 1 Alarm programmed for automatic discharge. If remote activation is used, no other detection devices should be installed on Circuit 1 Alarm.

Power Supply: In addition to the requirements as per 3.1 Power Supply Input, NSCV requires a secondary backup power supply. The FP-08870/08871 Power Control Module may be used for compliance. However, the recommended configuration is to use the vessel's emergency batteries, provided that the vessel has an automatic changeover for its power supply.

Equipment Shutdown: Any equipment that may impede operation of the fire system must be shutdown prior to system discharge. This includes any forced air ventilation and fuel supplies. This requires the installation of the FP-08860 Shutdown Relay Module.

Siren/Strobes: Siren/strobes must be installed and should clearly audible and visible at all points of the vessel. Fire alarms must be separate and distinct from any other alarm (including a different sound), so as to be easily distinguished when indicating a fire.

Detection: Due to typical operating conditions, thermal detectors (FP-08920) are the recommended detection device for most installations. However, NSCV limits the use of these detectors and cannot be used for spaces with a height more than 5 metres.