

FirePro Suppression System - BUS

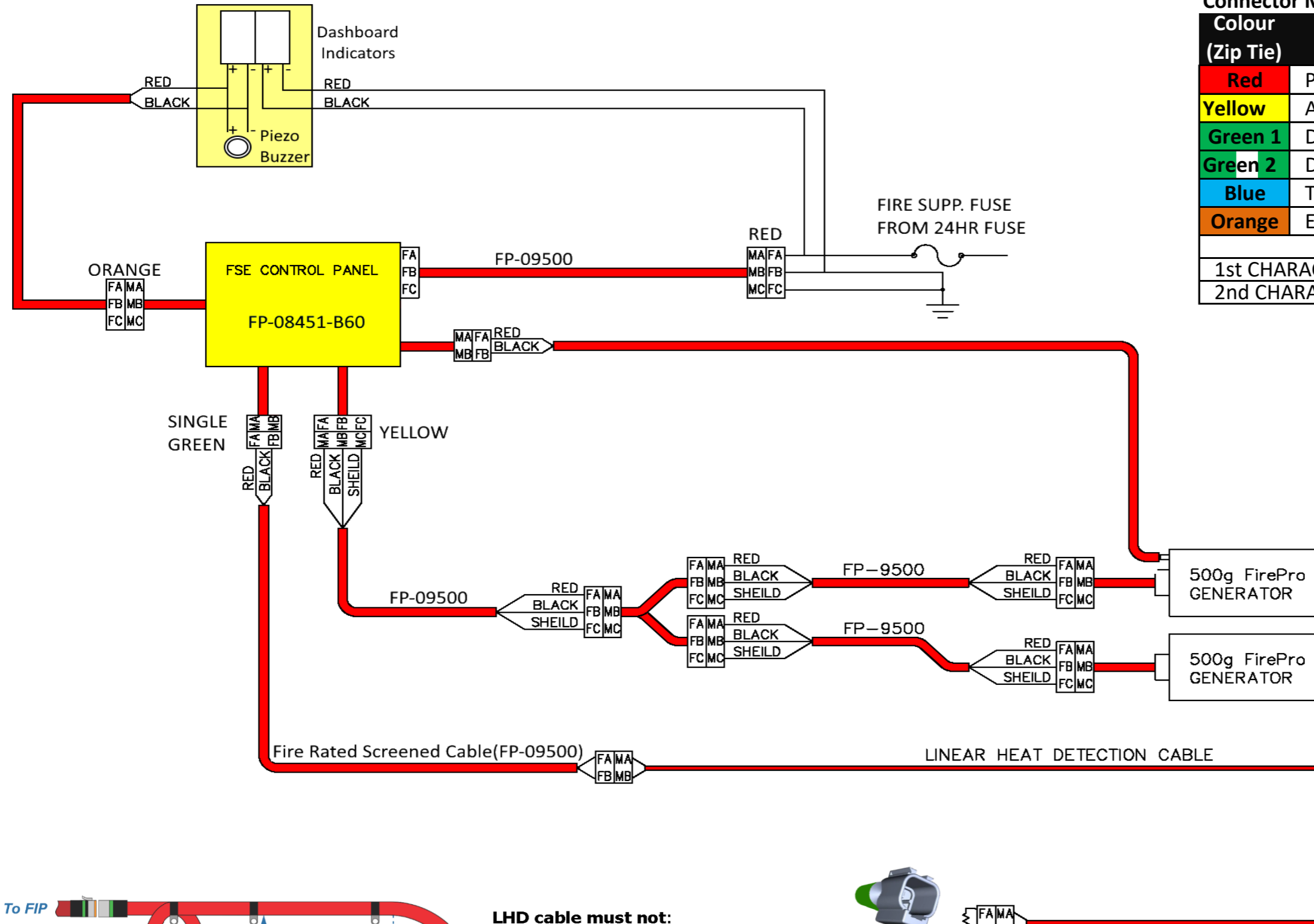

Connector Markings

Colour (Zip Tie)	Circuit
Red	Power
Yellow	Activation / Discharge
Green 1	Detection Circuit 1
Green 2	Detection Circuit 2 - NOT USED
Blue	Thermal Fuse
Orange	External Siren - Dashboard Indicator

1st CHARACTER (Male/Female) - CONNECTOR BODY
2nd CHARACTER (A,B,C) - TERMINAL DESIGNATION

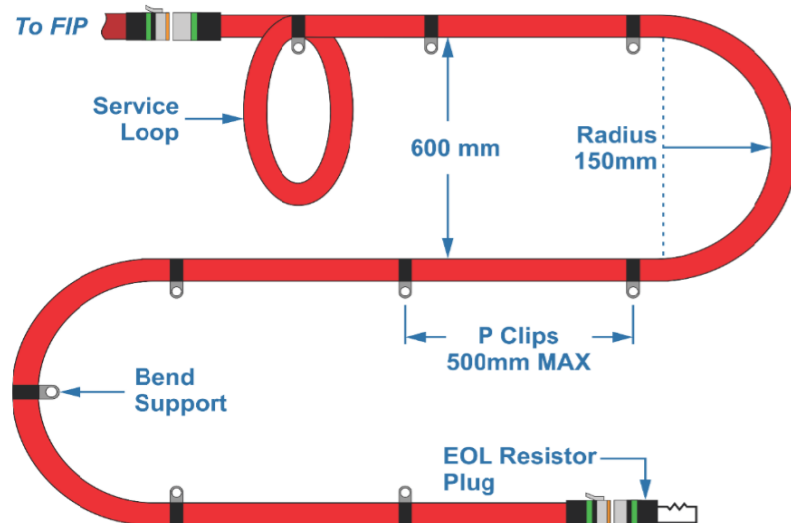
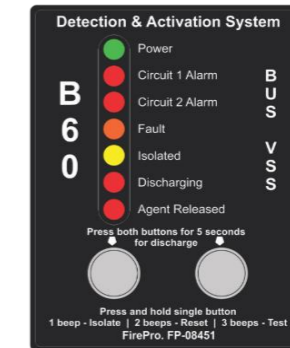

LHD cable must not:

- be bent using tools
- kinked during installation
- be painted
- enclosed in conduit, or other protection
- be spliced into - connections using Deutsch Plugs are approved



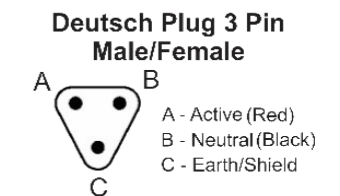





If the LHD cable is damaged by fire, the whole length must be replaced.

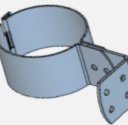









FIRE SAFETY EQUIPMENT PTY LTD				
Drawn By PM	Approved By	Title BUS System - B60	Drawing No BUS-1	Rev. F
Scale No	Date 15-10-23	FirePro Fire Suppression System		

FirePro Suppression System - BUS

BILL OF MATERIALS

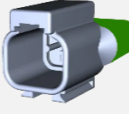
Part No	Qty	Description
FP-2000S	2	 500g SS Aerosol Generator
FP-06100	4	 HD SS Bracket to suit 100 - 500
FP-06920	1	 Dust Seals – to suit FP100-500 (Bag of 10)
FP-08451-B60	1	 Control Panel - FirePro detection and Activation Panel
DP-3010		 Deutsch Plug – 3 Pin Male, c/w pins and heatshrink to suit
DP-3020		 Deutsch Plug – 3 Pin Female, c/w pins and heatshrink to suit
DP-2010		 Deutsch Plug – 2 Pin Male, c/w pins and heatshrink to suit
DP-3010		 Deutsch Plug – 2 Pin Female, c/w pins and heatshrink to suit
FP-08945	1	 WaterProof Enclosure for Control Panel
FP-08918	1	 Splitter Cable, Red, No TVS

Part No	Qty	Description
FP-08800	1	 FirePro Test Module
FP-09500	10	 Cable 2 core 0.75mm Shielded FR x 1m
FP-08825	1	 Thermal Fuse with Coupling
FP-09510-08	1	 Linear Heat Detection 180deg C Cable x 8m with 2 pin Deutsch Plugs fitted
Misc	16	 P-clips to suit FP-09510 LHD
FP-08961	1	 Sign - System Warning Vinyl - BUS
FP-08950	2	 End of Line Resistor
Misc	1	 Dashboard LED Assembly
Misc	1	 Dashboard Piezo Buzzer

FIRE SAFETY EQUIPMENT PTY LTD				
Drawn By PM	Approved By	Title	Drawing No	Rev.
Scale No	Date 15-10-19	BUS System - B60 FirePro Fire Suppression System	BUS-2	F