

PTS-800

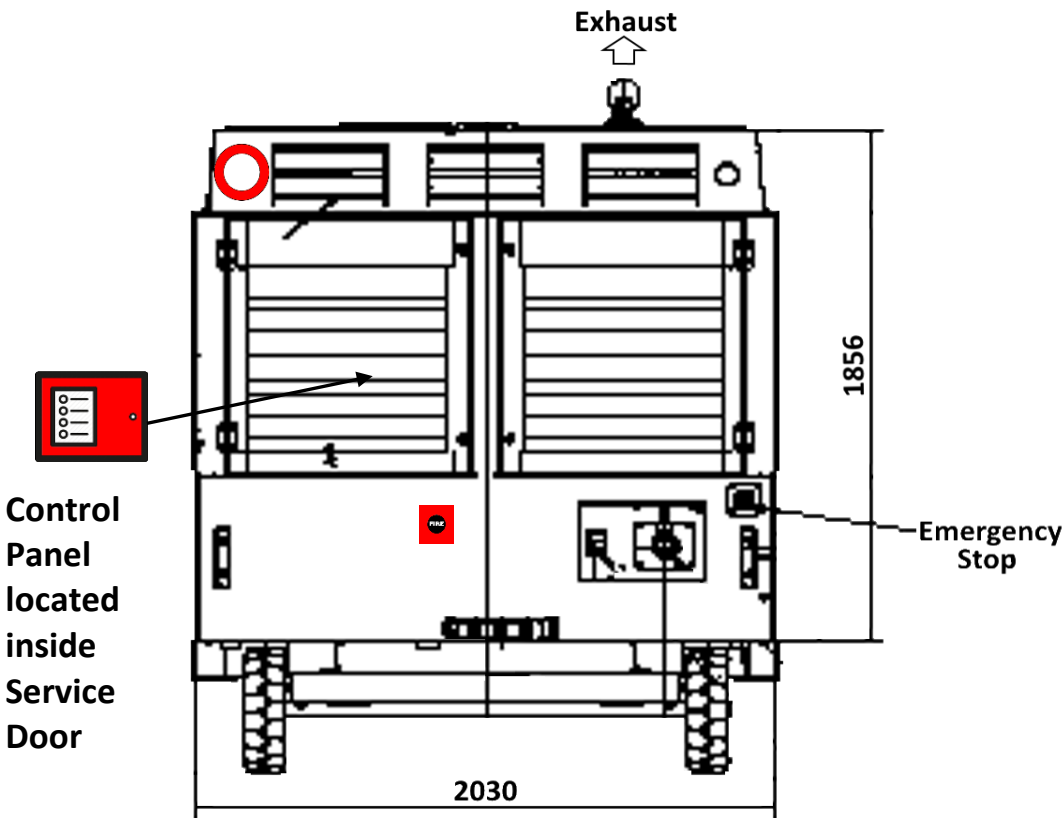

FRONT MOUNTED VIEW

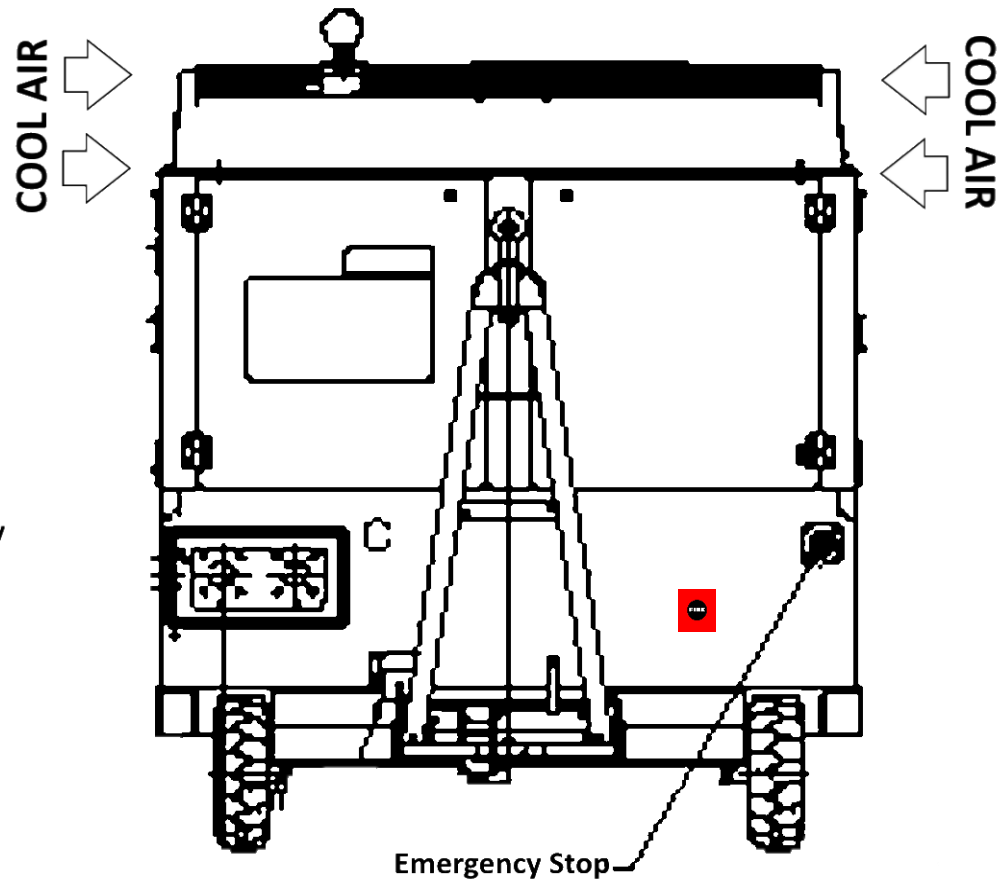





REAR MOUNTED VIEW

Notes:

- 1 Dimensions are in MM
- 2 Mounting of FirePro unit See drawing XRVS-1050-2
- 3 Mounting of Control Panel See Drawing XRVS-1050-3

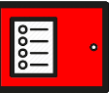
Components :

-  Manual Actuator
-  Siren Strobe
-  VSS Control Panel
-  FirePro Aerosol Generator - FP-0500S

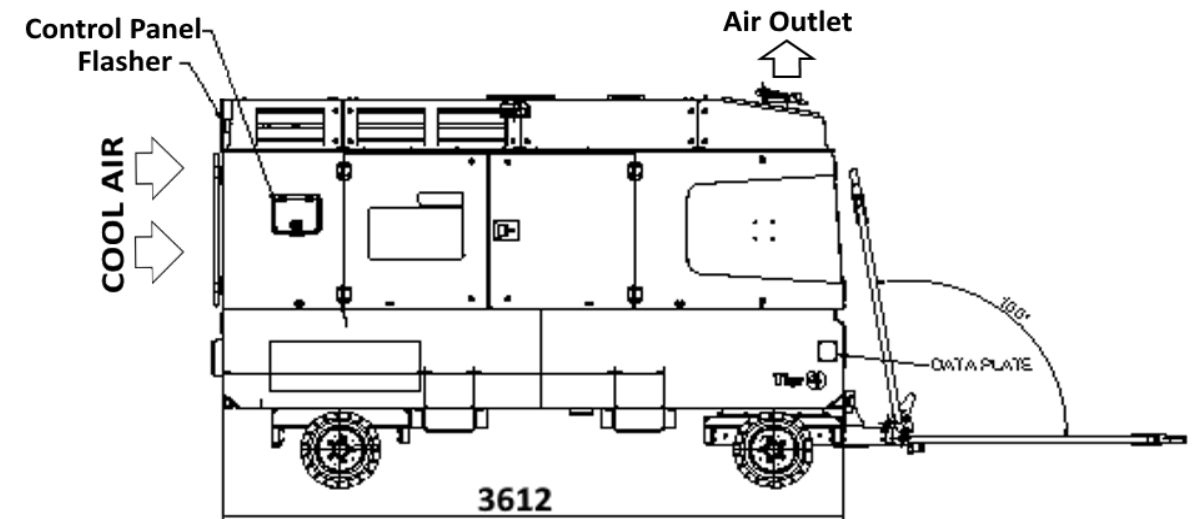
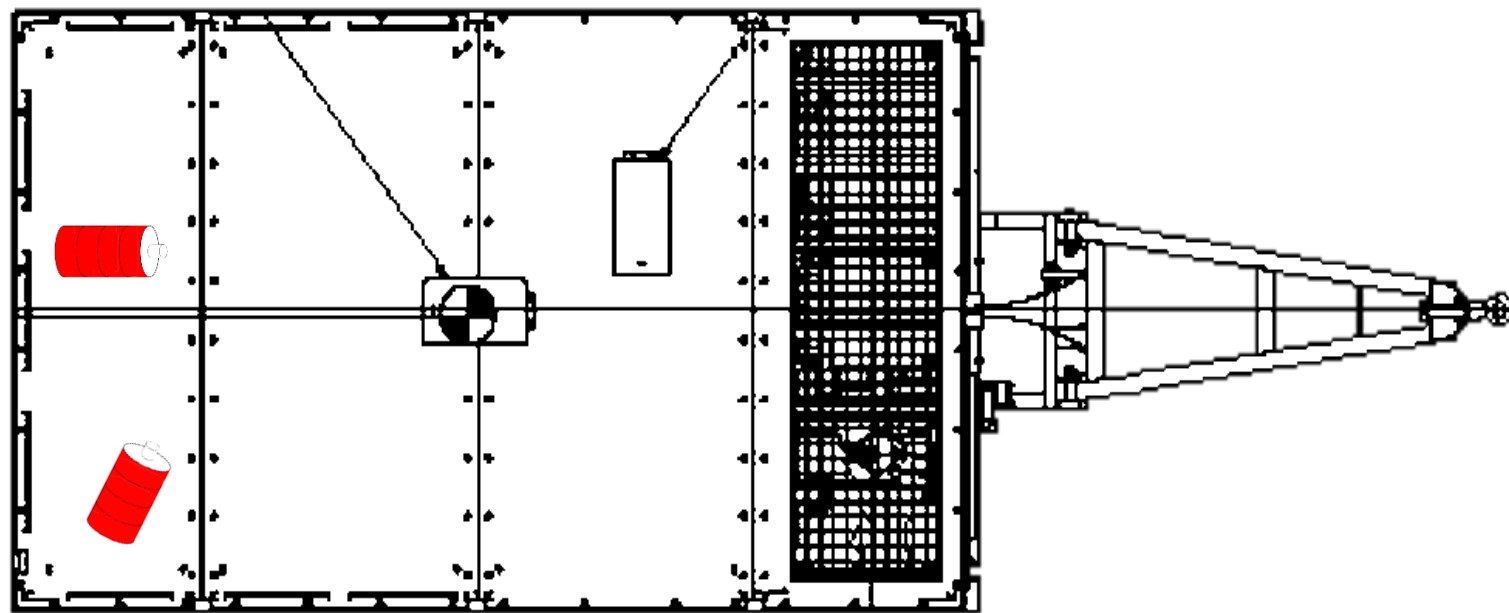
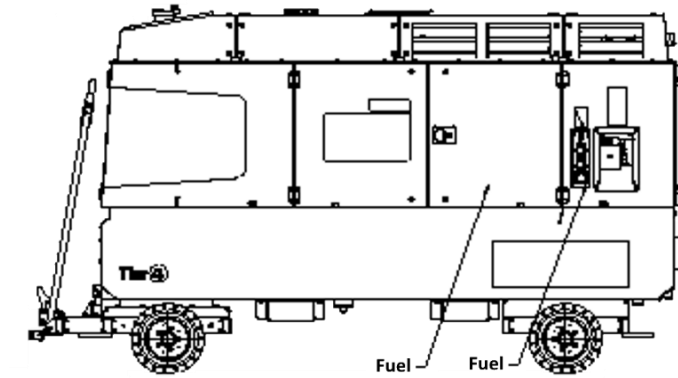

FIRE SAFETY EQUIPMENT PTY LTD

Drawn By PM	Approved By	Title	Drawing No	Rev.
Scale No	Date 15-10-19	Atlas Copco PTS-800 FirePro System General Arrangement	PTS-800-1	B

INSTALLED VIEW

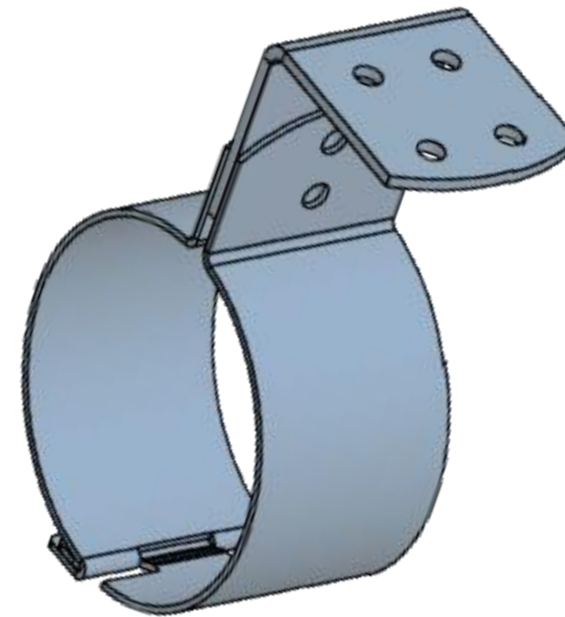

Standard FirePro Bracket

Notes:

- 1 Bracket Material - Mild Steel Bar 40 x 10mm - Painted
- 2 Dimensions are in MM
- 3 Holes in Bracket are for M10 Bolts
- 4 Mount Standard FirePro Bracket as shown

FIRE SAFETY EQUIPMENT PTY LTD					
Drawn By	Approved By	Title	Drawing No	Rev.	
PM		Atlas Copco PTS-800 FirePro System General Arrangement	PTS-800-2	B	
Scale	Date				
No	15-10-19				

PTS-800

INSTALLED VIEW

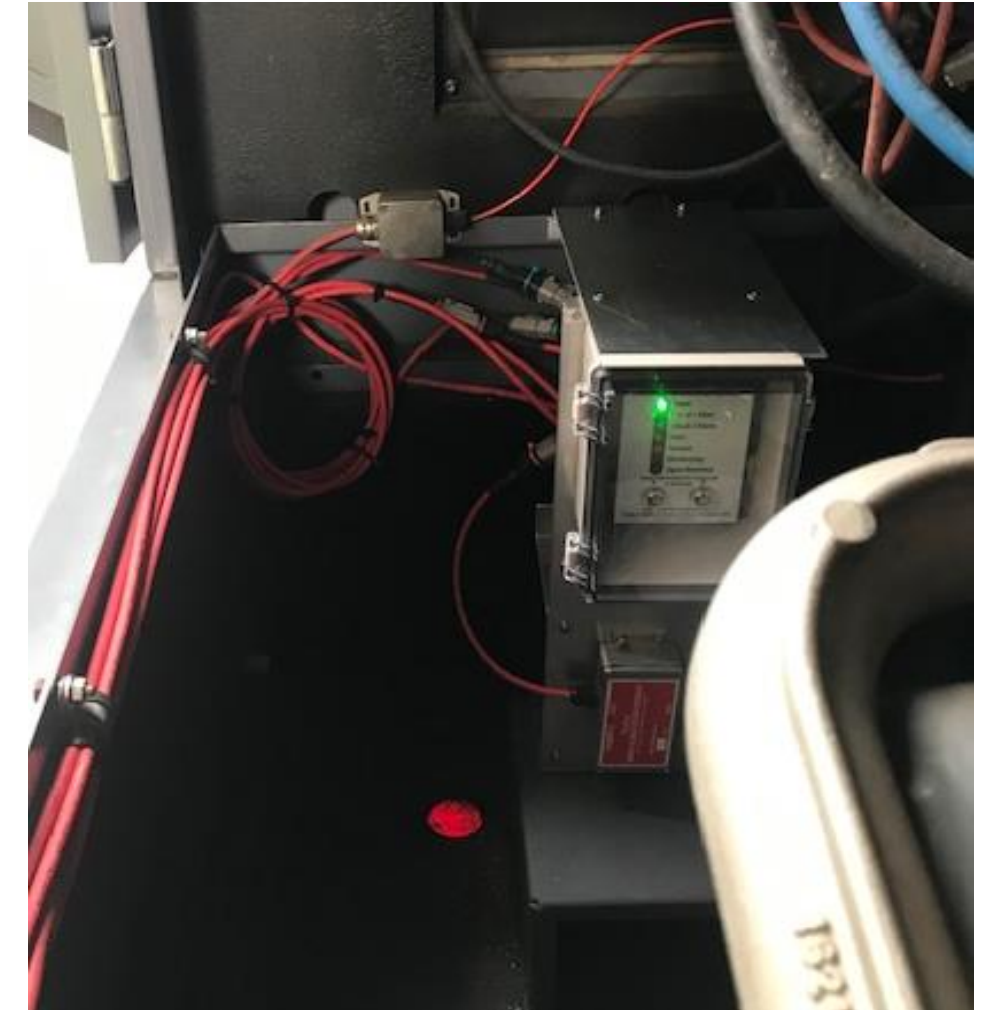
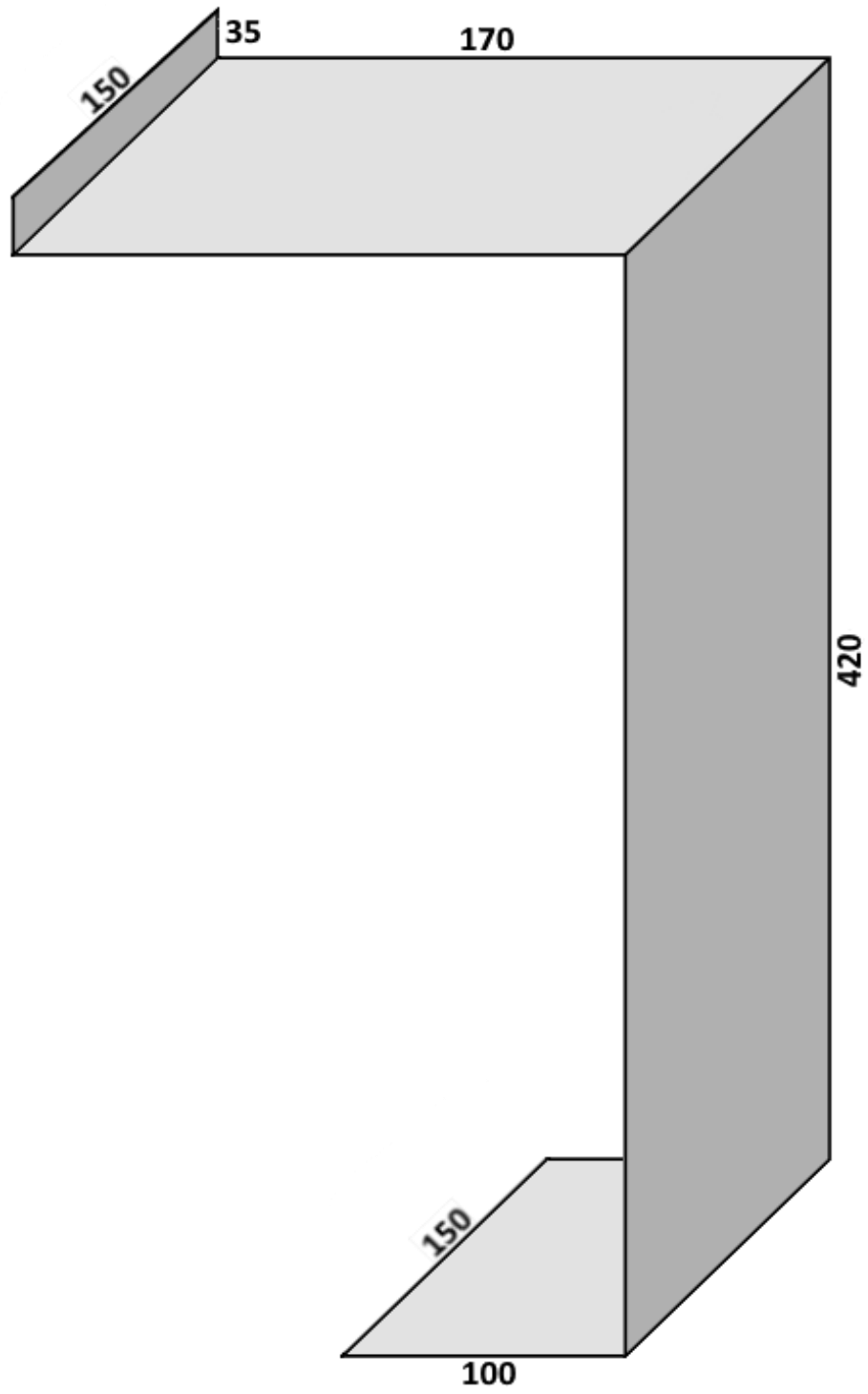

SIDE VIEW

TOP VIEW













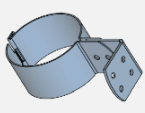







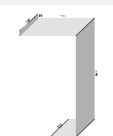

Notes:

- 1 Dimensions are in MM
- 2 Material Marine Grade Aluminium 3 mm

FIRE SAFETY EQUIPMENT PTY LTD				
Drawn By PM	Approved By	Title	Drawing No	Rev.
Scale No	Date 15-10-19	Atlas Copco PTS-800 FirePro System General Arrangement	PTS-800-3	B

PTS-800

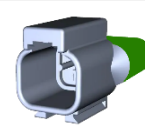
BILL OF MATERIALS

Part No	Qty	Description	Part No	Qty	Description
FP-0500S	2	 500g SS Aerosol Generator	FP-08860	1	 Shutdown Module - to suit 8451
FP-06200	4	 HD SS Bracket to suit 100 - 500	FP-08872	1	 Battery Backup Module 12-24vDC NiMH
FP-08800	1	 FirePro Test Module	FP-14053	2	 External Actuator Switch with Bracket
FP-06920	1	 Dust Seals – to suit 100-500	FP-14016	1	 Battery cable connection x 3m with 5A Fuse 2 Pin Male Deutsch Plug and Ballery Terminal Connectors
FP-08451	1	 Control Panel - FirePro detection and Activation Panel	FP-09500	30	 Cable 2 core 0.75mm Shielded FR x 1m
FP-08918	1	 Splitter Cable, Red, No TVS	FP-08825	1	 Thermal Fuse with Coupling
X-PTS-800-3	1	 Control Panel Bracket	FP-08940	1	 Siren / Strobe with EOL diode Installed
DP-3010	2	 Deutsch Plug – 3 Pin Male, c/w pins and heatshrink to suit	FP-09510-08	1	 Linear Heat Detection 180deg C Cable x 8m with 2 pin Deutsch Plugs fitted
DP-3020	2	 Deutsch Plug – 3 Pin Female, c/w pins and heatshrink to suit	Misc	16	 P-clips to suit FP-09510 LHD
DP-2010	4	 Deutsch Plug – 2 Pin Male, c/w pins and heatshrink to suit	FP-08961	1	 Sign - System Warning Vinyl - Vehicle
DP-2020	4	 Deutsch Plug – 2 Pin Female, c/w pins and heatshrink to suit	FP-08950	2	 End of Line Resistor
FP-08945	1	 WaterProof Enclosure for Control Panel			

FIRE SAFETY EQUIPMENT PTY LTD				
Drawn By	Approved By	Title	Drawing No	Rev.
PM		Atlas Copco PTS-800 FirePro System General Arrangement	PTS-800	B
Scale	Date			
No	15-10-19			